

INTERRUTTORI ORARI DIGITALI

memo

Digital time switches: User Manual

Manuale d'Uso



CE

 **Vemeter** SPA

Index

■ Safety warnings	page	3	■ Automatic programming	page	14
■ Technical characteristics	page	3	Creating a new programme	page	14
■ Dimensions	page	4	ON/OFF Programmes	page	14
■ Connection diagrams	page	4	IMPULSE Programmes	page	17
■ Display and keypad description	page	5	CYCLE Programmes	page	20
■ Installation	page	6	HOLIDAY Programmes	page	22
Setting language	page	7	Checking a programme	page	25
Setting date format	page	7	Displaying a programme	page	25
Setting date	page	7	Modifying a programme	page	26
Setting time	page	8	Deleting a programme	page	26
■ Programmings	page	9	Resetting programmes	page	27
ON/OFF Events	page	9	■ Settings menu	page	28
IMPULSE Events	page	9	LANGUAGE menu	page	28
CYCLE Events	page	9	DATE menu	page	29
Holiday Events	page	9	TIME menu	page	30
Programming priority	page	10	CHANGE CET/DST menu	page	30
■ Manual operation	page	11	CASUAL PARAMETERS menu	page	33
Manual switching on/off	page	11	PROGRAMME OPTIONS menu	page	34
Casual switchings on/off	page	11	PIN menu	page	35
Lock output switchings (Lock)	page	12	RESET menu SETTINGS	page	36
Battery test	page	12	■ Meter menu	page	36
IR interface activation IR	page	12	■ Reset menu	page	37
Menu Overview	page	13	■ IR Interface	page	37
			Copy function	page	38
			Paste function	page	38
			■ Battery replacement	page	39
			■ Reference Standards	page	40

Digital programmable switches

Digital programmable switches



- Large display with text guide to facilitate programming
- Sealable cover and possibility to lock keypad through password

- Four models are available:
 - with 1 or 2 relays
 - with daily/weekly programming or daily/weekly/monthly/yearly programming



- IR remote control (available as an accessory) for transferring programmes from and to the instrument



- Possibility of a programmes archive (up to 126) always available



- Cover on the back of the instrument for replacing the battery

SAFETY WARNINGS

- 1) The instrument must be installed and started up by a qualified person, strictly in observance of the connection diagrams shown in this manual.**
- 2) After installation inaccessibility to the terminals without using dedicated tools must be guaranteed**
- 3) Before accessing the connection terminals, make sure that the leads are not live.**
- 4) Do not connect or feed the instrument if any part of it is damaged**
- 5) The instrument must be installed and activated in compliance with current electric systems standards.**
- 6) Do not use the instrument for anything other than the indicated purpose**

Code	Model	Description
VE339800	memo DW	1 relay daily/weekly clock
VE341400	memo DW2	2 relay daily/weekly clock
VE340600	memo Y	1 relay daily/weekly/monthly/yearly clock
VE342200	memo Y2	2 relay daily/weekly/monthly/yearly clock

TECHNICAL CHARACTERISTICS

- Power supply: 230Vac \pm 10% 50/60Hz
- Absorption: 8VA (2W)
- Replaceable battery
- Output: - 1 monostable change-over contact 16(10)A / 250Vac (versions DW and Y)
- 2 relays with monostable change-over contacts 16(10)A / 250Vac (versions DW2 and Y2)
- Type of action: 1B
- Memorisable programmes (for each channel):
- 30 events (on, off, impulse, cycle)
- 4 periods + 20 holiday days
- Backlit LCD display
- Integrated IR interface with 0.5m range with direct solar light (2m in the dark)
- IR transmission frequency: 31.25kHz
- Software class: A
- Mounting: DIN rail to backplane
- Container: 2 DIN modules
- Operating temperature: $-20^{\circ}\text{C} \div +40^{\circ}\text{C}$
- Storage temperature $-10^{\circ}\text{C} \div +70^{\circ}\text{C}$
- Pollution level: 2
- Rated impulse voltage: 4kV
- Degree of protection: IP20 for the terminals
- Insulation: reinforced between accessible parts (frontal) and all the other terminals

DIMENSIONS

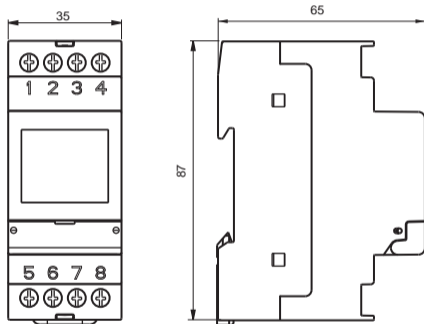

CONNECTION DIAGRAMS

Memo DW
Memo Y

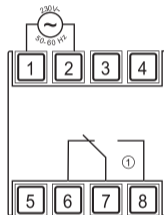

Memo DW2
Memo Y2

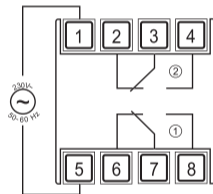

DISPLAY AND KEYPAD DESCRIPTION

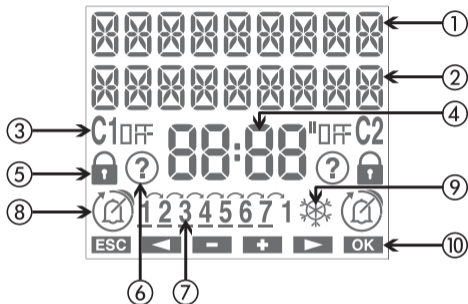

- ① Field **“text1 / day”**
- ② Field **“text 2 / date”**
- ③ Field **“status relay1”**
- ④ Field **“time”**
- ⑤ Field **“lock”** (lock relay switchings)
- ⑥ Field **“random programme”**

- ⑦ Field **“day of the week”**
- ⑧ Field **“programme running”**
- ⑨ Field **“CET/DST”**
- ⑩ Field **“key functions”**



- Key **“←”**: activation menu/esc/check battery
- Key **“Ok”**: confirm datum/activation IR transmission
- Key **“C1”**: decrease datum/previous menu/ switching channel 1/lock channel 1
- Key **“C2”**: increase datum/next menu/ switching channel 2/lock channel 2
- Key **“R”**: reset settings

- Key **“Ok”** + **“C1”** (3 sec): random on/off channel 1
- Key **“Ok”** + **“C2”** (3 sec): random on/off channel 2

INSTALLATION

- The instrument is supplied with the battery not inserted to avoid wasted consumption. Extract the battery from its packing and insert it into the housing located behind the instrument **so that pole (+) is visible as shown in the figure**. Then secure the closure cover, turning it clockwise.

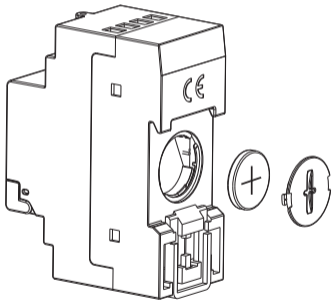

- Connect the load and the power supply as illustrated in section "Connection diagrams"

- Using a pointed object press key "R" to perform a reset. All the segments of the display will light for a few seconds and then the instrument will enter IR receipt mode (before it enters receipt mode the version of the firmware and the type of instrument, memo DW or memo Y appear without specifying the number of channels).
Note: in case of powerfail, IR receipt is not activated

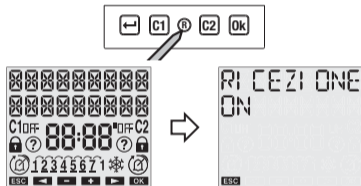

- Press key "←" to exit the IR receipt mode (should you wish to transfer the programmes from the remote control see section "IR Interface" page 37)
- At this point it is possible to insert the parameters necessary for the instrument to work correctly:
 - language
 - date format
 - date
 - time

Setting the language

It is possible to choose from 5 languages:
Italian → English → Spanish → French → German

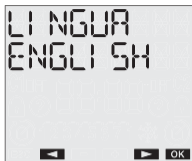

Use keys “C1” and “C2” to choose the desired language.



Press “Ok” to confirm and go on to the “data format” menu.



Setting data format

It is possible to choose from two data formats:
DD-MM-YY or YY-MM-DD

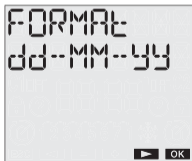

Use keys “C1” and “C2” to choose the desired format.



Press “Ok” to confirm and go on to the “data” menu.



Setting the date

The parameter (year, month, day) to be changed flashes.



Use keys “C1” and “C2” to choose the desired value - and press “Ok” to confirm and go on to the next parameter. The sequence of parameters to be entered is year → month → day

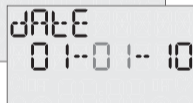

When the day is inserted, also appearing on the display is the bar with the corresponding day of the week (1 → Monday, 7 → Sunday).



Press **"Ok"** to confirm and go on to the "data" menu.



Setting the time

The parameter (hours, minutes) to be changed flashes.

Use keys **"C1"** and **"C2"** to choose the desired value - and press **"Ok"** to confirm and go on to the next parameter. The sequence of parameters to be inserted is hours → minutes

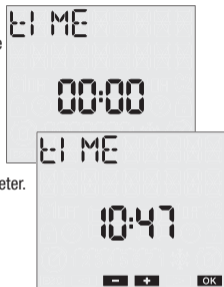

Press **"Ok"** to confirm.



The instrument then goes into **normal operational status** and is ready to work.

The display shows the values for the date, time, status relay 1, status relay 2 (when present), day of the week (on the first line in letters and lower down in numbers) and the DST/CET symbol.



Note: if the instrument is not fed by the mains, on the first line of the display instead of the day are the words **NO SUPPLY**.

In this condition backlighting is not active and the relay not switched.

PROGRAMMINGS

Events ON/OFF

ON and OFF events consist of switching the relay to the on or off position.

They may be daily (every day at the same time), weekly (one or more days during the week, each week) monthly (one day a month, every month), yearly (one day a year, every year).

IMPULSE event

An impulse event can be an on or off type and may last for a maximum of 59 seconds:

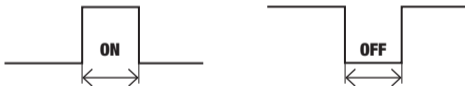

At the end of the on impulse the relay will always be in the off status; at the end of an off impulse the relay will always be in the on status.

An impulsive event can be interrupted following a manual operation or IR transmission activation.

CYCLE events

A cycle event is a programme which repeats itself over a preset period of time (maximum duration 1 week) during which there is a succession of on and off switching.

The cycle programme always starts from the on status and always ends in the off status. The duration of the on and off status cannot be less

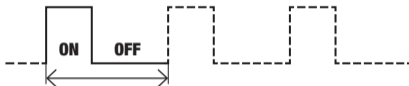

than one minute.

The cycle event may be interrupted following a holiday event (relay status:off), a manual operation, a date/rime change, automatic updating of CET/DST time or IR transmission activation (we recommend disabling the automatic time change when using the cycle programme).

HOLIDAY events

A holiday event allows you to enter individual days or holiday periods during which all the set programmes shall not be carried out and the relay shall be in the off position.

Holiday events always start at 00:00 on the starting day and end at 23:59 on the last day of the holiday.

Holiday events are interrupted in the case of manual operations on output.

Programming priority

In automatic function mode the instrument behaves as foreseen by the entered programmes. Should there be conflict between programmes (different events starting at the same moment) the instrument will only run the one with the highest priority, according to the following table (1 maximum priority, 10 minimum):

Event	Yearly	Monthly	Weekly	Daily
Holiday	1	-	-	-
Cycle	-	-	2	-
Impulse	3	4	5	6
ON or OFF	7	8	9	10

Programmed events which starting during an event already in progress (holiday, cycle) are ignored.

In the case of non-instantaneous (holiday, cycle, impulse) the device always completed the started programme before managing the next.

Exceptions to this are cases in which:

- a holiday event occurs while executing a non-instantaneous programme
- there is a change to manual operation while executing a non-instantaneous programme. In this case all the programmes running are interrupted and if there is a lock or random on the channel, execution of all programmes is disabled until manual procedure is deactivated

- IR transmission is activated while executing the programme

Programmes that are active when one of these exceptions occurs are interrupted and will not be restored. When execution is interrupted, the relays still maintain status unless entering a holiday day (or period) or if IR transmission is activated (relay set to off).

MANUAL OPERATION

Manual operation allows an output (or outputs) on the instrument to be worked manually, as well as as reading the battery charge level and activating the IR interface.

Manual operations are reachable from the normal operational status in which the display assumes an appearance similar to the following:



Manual switching on/off

Briefly pressing keys "C1" or "C2" allows 1 or relay 2 (if present) switching. The achieved status is maintained until the next programmed event.

Casual on/off switchings

It is possible to activate casual output switching. Activation brings the output to the on

status and shall then be followed by on/off switching with casual periods and duty-cycles (the default minimum period is 1 minute and the maximum 5 minutes: such values can in any case be changed in the settings menu)

Hold keys "C1" and "Ok" down simultaneously for 3 seconds to activate the function on channel 1 or "C2" and "Ok" to activate the function on channel 2 (if present).



On confirmation of activation, under the output status indication appears the symbol (?)

Pressing keys "C1" and "Ok" again for 3 seconds (or "C2" and "Ok") deactivates the function.

The relay is set to off status. If the function is active on both channels (only for **memo DW2** and **memo Y2**), the outputs shall switch simultaneously.

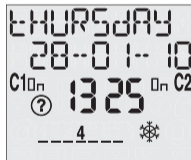

Lock output switching (Lock)

It is possible to activate the function which allows all the switchings of one output to be locked. In this way all the programmes are locked (including the holiday programme and the other manual switchings) and the output is maintained in its current status until manual unlocking.



Hold key “**C1**” down for 3 seconds to activate output 1 locking (“**C2**” for output 2, if present).

On confirmation of activation, on the display under the channel indication appears symbol .

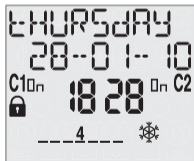
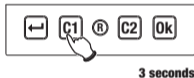
Hold key “**C1**” down for 3 seconds (or “**C2**” for output 2) to unlock the output.



Battery Test

The battery is read automatically once a week (Monday at 00:00). It is in any case possible to read battery status by holding down key “←” for 3 seconds. On the display appear the words  if the battery charge level is sufficient for correct operation; otherwise the words  appear to indicate that replacement is required as soon as possible.

IR interface activation

The IR interface allows programmes and settings to be transmitted from and for the remote control. Activation of the IR interface comes about by completely resetting the instrument, pressing key “**R**” if you wish to transfer programmes from the remote control to the instrument, or pressing the “**OK**” key for 3 seconds if you want to transfer programmes from the instrument to the remote control (in the case the outputs are set on OFF).

**The manual functions which work on the output relays have priority over any set programming.
The highest priority function is the lock switchings function (LOCK).**

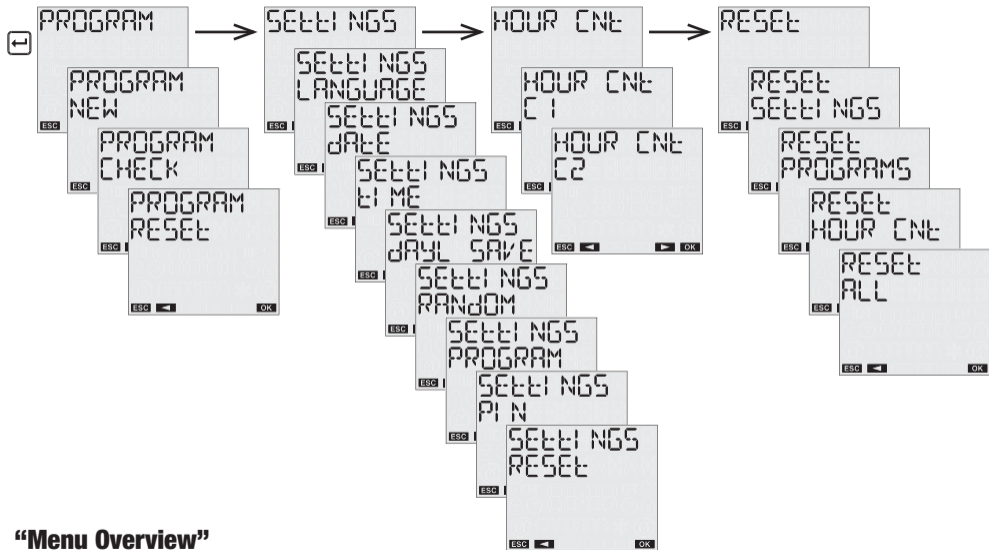

“Menu Overview”

AUTOMATIC PROGRAMMING

1. Creation of a new programme

1.1 Programmes ON / OFF

Press key “←” to enter the menu, choose the PROGRAM option using keys “C1” and “C2” and press “Ok” to confirm.

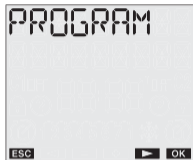

Choose option NEW using keys “C1” and “C2” and press “Ok” to confirm.



Choose the channel onto which to carry out the programming through keys “C1” and “C2”. You can choose whether to execute the programme on channel 1 on channel 2 or on both channels simultaneously. Press “Ok” to confirm.

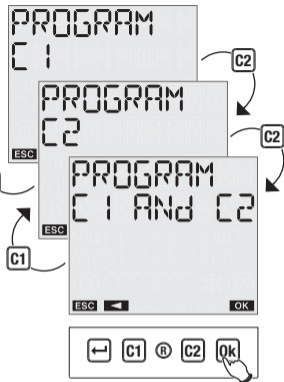

This choice is only available on memo DW2 and memo Y2 models.

Using keys "C1" and "C2" choose the frequency of the event from:

DAILY, WEEKLY, MONTHLY, YEARLY.
Press "Ok" to confirm.

For DW memo and DW2 memo models, monthly and yearly programmings are not available.

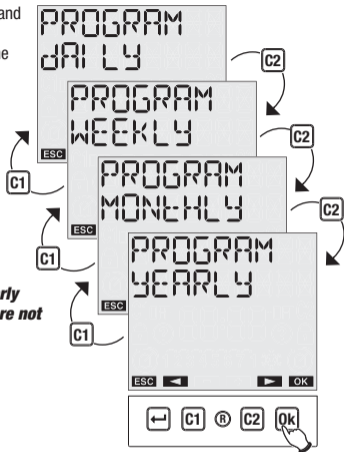

Choose between an ON or OFF event.
Press "Ok" to confirm.

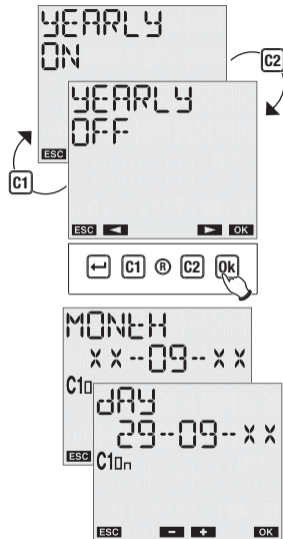

Insert the date using keys "C1" and "C2".
(not required for daily events)
For weekly events it is possible to set more than one day of the week. By pressing key "Ok" you select/deselect the day in question while using key "C2" you scroll through

the days until Sunday. By pressing “C2” again, CONFIRM appears: press “OK” to confirm.



Enter the hours and minutes for the switching using keys “C1” and “C2”. Press “OK” to confirm.



Confirmation of programming is shown by the words SAVED on the display with the concerned channel.

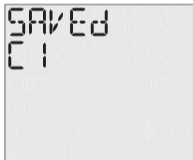

Note: recursive function

At this point the instrument activates the recursive function which allows several on-off events to be programmed in succession on the same day.

Thereby once an activation (deactivation) event has been programmed, it is possible to enter the time of a deactivation (activation) event for the same day.

If you do not wish to enter an off (on) time, press key “←” to terminate programming.

There is no control of the correlation between on/off events programmed using the recursive function: such function is therefore to be intended as facilitated programming.

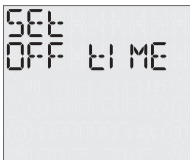

1.2 IMPULSE programmes

Press key “←” to enter the menu, choose the PROGRAM option using keys “C1” and “C2” and press “Ok” to confirm.



Choose option NEW using keys “C1” and “C2” and press “Ok” to confirm.



Choose the channel onto which to carry out the programming through keys “C1” and “C2”. You can choose whether to carry out the programme on channel 1 on channel 2 or both channels simultaneously. Press “Ok” to confirm.

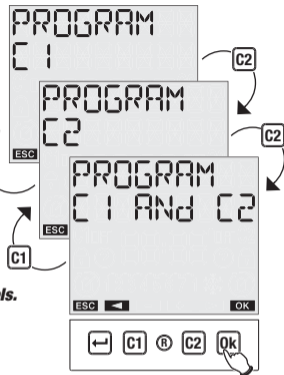

This choice is only available on memo DW2 and memo Y2 models.

Using keys "C1" and "C2" choose the frequency of the event from:

DAILY, WEEKLY, MONTHLY, YEARLY.

Press "Ok" to confirm.

For DW memo and DW2 memo models monthly and yearly programmings are not available.

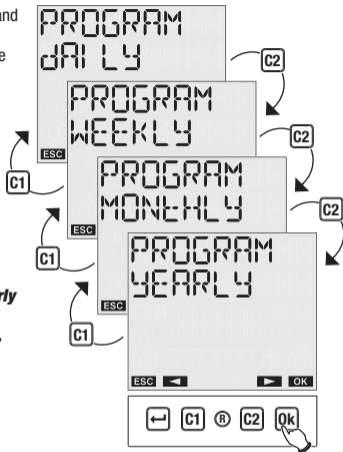

Choose the impulse using keys "C1" and "C2" and press "Ok" to confirm.

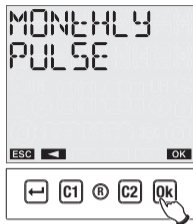

Using keys "C1" and "C2" choose whether it is an ON impulse or an OFF impulse. Press "Ok" to confirm.

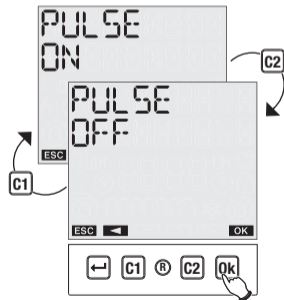

Set the date using keys “C1” and “C2”
(not required for daily events).
Press “Ok” to confirm.

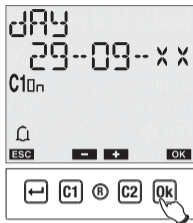

Enter the starting time and duration of
the impulse (max 59 seconds).



Press “Ok” to confirm.

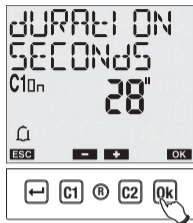

Once programming is confirmed, on
the display the are shown the words
SAVED
with the channel concerned (C1 or C2).

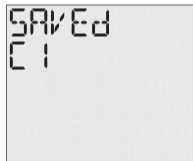

During normal operation, the eventual
execution of an impulse programme is
shown by symbol  on field (8) of the
display.

1.3 CYCLE Programmes

Press key “←” to enter the menu, choose the PROGRAM option using keys “C1” and “C2” and press “Ok” to confirm.



Choose option NEW using keys “C1” and “C2” and press “Ok” to confirm.

Choose the channel onto which to carry out the programming through keys “C1” and “C2”. You can choose whether to carry out the programme on channel 1 on channel 2 or both channels simultaneously. Press “Ok” to confirm.

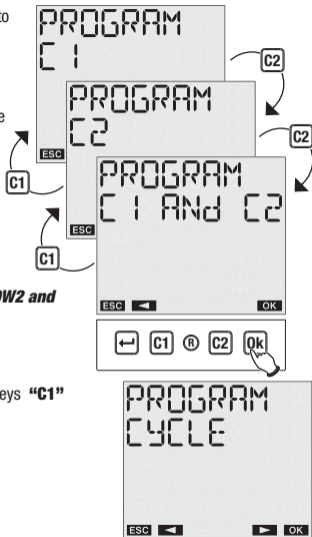

This choice is only available on memo DW2 and memo Y2 models.

Choose CYCLE with keys “C1” and “C2”.

Press **"Ok"** to confirm.



Enter the day and time (hours, minutes) of cycle start, the duration of the ON period (hours, minutes), the duration of the OFF period (hours, minutes), the date and time (hours, minutes) of cycle end (the device will give some possible values for the end of the event: such values are calculated so that the last period is always complete). The maximum duration of a cycle is one week.

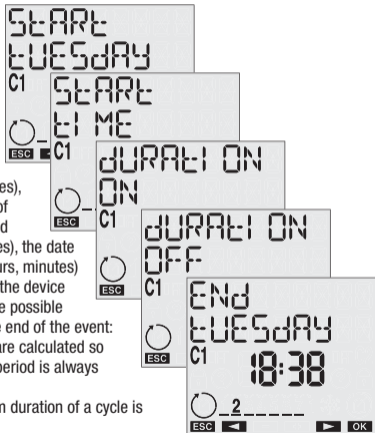

Press **"Ok"** to confirm.



Once programming is confirmed, on the display appear the words **SAVED** with the channel concerned (C1 or C2).

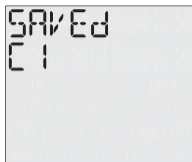

During normal operation, the eventual execution of a cycle programme is shown by symbol  on field (8) of the display.

1.4 HOLIDAY programmes ↗

Press key “←” to enter the menu, choose the PROGRAM option using keys “C1” and “C2” and press “Ok” to confirm.



Choose option NEW using keys “C1” and “C2” and press “Ok” to confirm.

Choose the channel onto which to carry out the programming through keys “C1” and “C2”. You can choose whether to carry out the programme on channel 1 on channel 2 or both channels simultaneously. Press “Ok” to confirm.

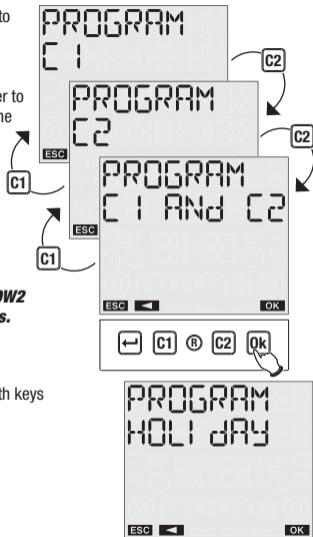

This choice is only available on memo DW2 and memo Y2 models.

Choose HOLIDAY with keys “C1” and “C2”.

Press **"Ok"** to confirm.



Choose
one days' holiday
or
a holiday period
using keys **"C1"** and **"C2"**

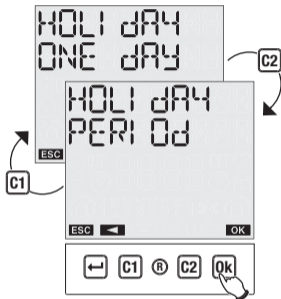

Press **"Ok"** to confirm.

Insert the date
(holiday day)
or
the interval of holiday days
(holiday period).

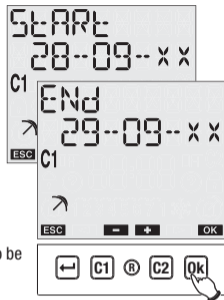

Press **"Ok"** to confirm.

Note: the details of the interval are to be considered as included in the period.

As confirmation of programming, on the display appear the words **SAVED** with the channel concerned (C1 or C2)

During normal operation, the eventual execution of a holiday programme is shown by symbol \curvearrowright on field (8) of the display.

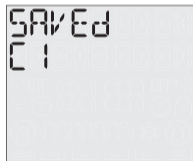

Note: recursive function

At this point the instrument activates the recursive function which allows several holiday days (or holiday periods) to be programmed in succession.

If you do not wish to enter another days' holiday (or period), press key "←" to end programming.

There is no control of the correlation between holiday events programmed using the recursive function: such function is therefore to be intended as facilitated programming.



The instrument's internal memory allows up to 30 events + 4 holiday periods + 20 holiday days to be memorised (for memo DW2 and memo Y2 models these quantities are to be intended as valid for each channel).

Once maximum capacity is reached, attempts to memorise another programme causes the display to show the message MEMORY FULL. In this case it is necessary to delete a programme in the memory in order to enter a new one(in the case of contemporary programming on two channels, at least one position in the memory must be available for each channel).

The message ERROR is shown on the display whenever there is an attempt to save a programme overwriting a pre-existent programme of the same type (for example trying to enter a daily off event at 08:00 if there is already a daily on event at the same time).

2. Checking a programme

Through this menu it is possible to display, amend or delete a programme saved in the instrument.

2.1 Displaying a programme

Press key "**↵**" to enter the menu, and using keys "**C1**" and "**C2**" choose the PROGRAM option.

Press "**OK**" to confirm.



Using keys "**C1**" and "**C2**" choose CHECK

Press "**OK**" to confirm.

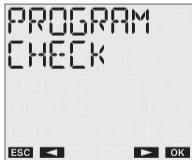

Choose the channel on which you wish to check the programme (choice available only for memo DW2 and memo Y2 models)

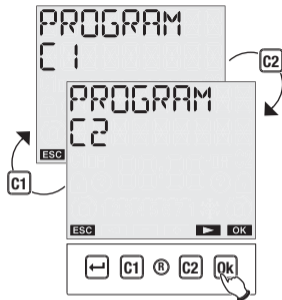

Finally, choose the frequency and type of event you wish to check using "**C1**" and "**C2**".

At this point the first programme pertaining to the specified type is displayed.

If more than one programme is present, it is possible to scroll forwards and backwards through them by using keys "**C1**" and "**C2**".

If no programme of that particular type is present, on the display appear the words **EMPTY**.

2.2 Modifying a programme

It is possible to access programme modification from the programme display status.

Choose the programme to be modified and press key **"Ok"**

Choose the MODIFY option using keys **"C1"** and **"C2"** and press **"Ok"** to confirm.

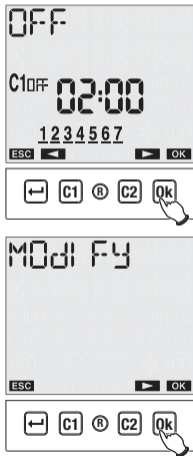

At this point it is possible to insert the new programme parameters. The parameter under modification flashes. Use keys **"C1"** and **"C2"** to set the values and **"Ok"** to confirm or the key **"←"** to exit without modifications.

At the end of the modification the words **SAVE** are displayed with the channel concerned (C1 or C2) and the instrument returns to the normal operational status once again.

2.3 Deleting a programme

It is possible to access programme deletion from the programme display status.

Choose the programme to be deleted and press key **"Ok"**

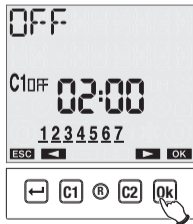

Choose, using keys **"C1"** and **"C2"** the DELETE option and press **"Ok"** to confirm or key **"↵"** to exit without deletion.

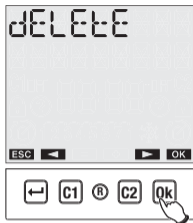

On the display appear the words **DELETE** followed by the channel concerned (C1 or C2) and the instrument returns to normal operational status once again.

Note: in the case of CYCLE programme, the menu sequence differs slightly. In fact in this case the first parameter of the first cycle programme is displayed (start time). It is necessary to press key **"C2"** to display all the parameters relative to that programme until the **"Ok"** key is enabled which allows access to the menu containing the options *modify, delete* and *next* (to go to the next programme cycle). At this point using keys **"C1"** and **"C2"** choose the desired option and press **"Ok"** to confirm.

3. Reset programmes

To delete all the programmes saved on the instrument:

Press key **"↵"** to enter the menu, choose the PROGRAM option using keys **"C1"** and **"C2"** and press **"Ok"** to confirm.

Choose option RESET PROGRAM using keys **"C1"** and **"C2"** and press **"Ok"** to confirm.

Choose CONFIRM and press **"Ok"**. All the programmes will be cancelled.

Alternatively it is possible to reset programmes by accessing the reset menu (see Reset menu page 37)

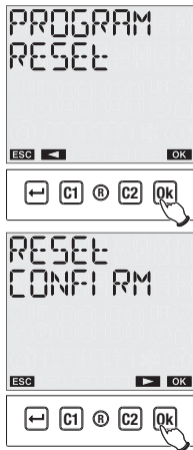

SETTINGS MENU

This menu allows the instrument's general configuration parameters to be displayed and eventually modified.

These are:

language, date, time, DST, casual programme option and pin.

From the normal operational status

- press key “↵”



- choose SETTINGS using keys “C1” and “C2”



- press “Ok” to confirm.



LANGUAGE Menu

- choose SETTINGS LANGUAGE using keys “C1” and “C2”
- confirm with “Ok”



- the currently set language is displayed: press “Ok” to access the modification



- choose the language using keys “C1” and “C2”

- confirm again with “Ok”

- on the display appear the words 'SAVED'



The options are:
Italian, English, Spanish, French and German.



- choose the date format using keys **"C1"** and **"C2"** (dd-mm-yy or yy-mm-dd)

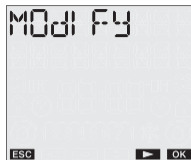

- confirm with **"Ok"**



DATE Menu

- choose SETTINGS DATE using keys **"C1"** and **"C2"**
- confirm with **"Ok"**
- the current date is displayed: press **"Ok"** to access the modification

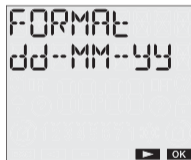

- enter the year, month and date using keys **"C1"** and **"C2"**
- press **"Ok"** again to confirm
- On the display appear the words DATE



TIME Menu

- choose SETTINGS TIME using keys **"C1"** and **"C2"**
- confirm with **"Ok"**
- the current time displayed: press **"Ok"** to access the modification
- enter hours and minutes using keys **"C1"** and **"C2"**
- press **"Ok"** again to confirm
- On the display appear the words SAVE

CHANGE CET/DST Menu

DST/CET management can be carried out automatically by the device. In this case, the instrument:

- increases the current time by one hour when changing from CET to DST
- decreases the current time by one hour when changing from DST to CET

To enable/disable the automatic time change:

- choose SETTING DAYL SAVE using keys **"C1"** and **"C2"**
- confirm with **"Ok"**. The current status is displayed (AUTO ON or AUTO OFF)
- press **"Ok"** to enter modification
- using keys **"C1"** and **"C2"** choose whether to activate or deactivate the function
- press **"Ok"** to confirm

If you choose AUTO OFF, on the display appear the words SAVE , otherwise the

instrument remains within the menu to allow the time change days to be set.

To set the days and the time in which CET/DST time change occurs:

- choose SETTINGS DAYL SAVE using keys **"C1"** and **"C2"**
- confirm with **"Ok"**. The words AUTO ON appear on the display (should this not happen, see previous paragraph "Enable automatic time change")



- press key **"C2"**. The time change parameters from CET to DST appear on the display

- by pressing key **"Ok"** it is possible to modify such values. The parameters to be entered are sequentially:

- week
- month
- day (or date)
- time

- week of the month: first 1ST, second 2ND, third 3RD, fourth 4TH, LAST last (meant for example as the last Sunday, Monday, ...of the month) or DATE (to specify a precise date)

For example, the figure at the top shows that the time change happens on the last (LAST) Sunday (7) of March (03) at 2 (02:00)



- month of change



- if you have chosen date the day of the month is requested; in the other cases you are asked to enter the day of the week on which the time change is to happen. Press **"Ok"** to confirm



- enter the time of the change Press **"Ok"** to confirm



- by pressing key **"C2"** it is possible to set the moment in which the time change from CET to DST occurs in the same way



When all the parameters have been set, press **"↵"** to exit.

Depending on the date, on the instrument display appears the symbol ❄️ during the CET period (winter) and the ☀️ symbol during the DST period (summer).

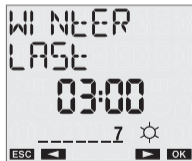

CASUAL PARAMETERS Menu

This menu allows the modification of the minimum and maximum time which passes between two switchings when a casual programme is activated. As default these values are set at 1 and 5 minutes.

- choose SETTINGS RANDOM using keys **"C1"** and **"C2"**
- confirm with **"Ok"** . The minimum duration value is displayed
- press **"C2"** to display the maximum duration



- press **"Ok"** to enter into modification
- enter sequentially
 - hour, minutes, minimum time
 - hour, minutes, maximum time

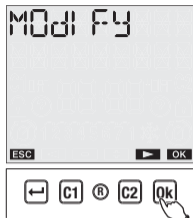

- press **"Ok"** to confirm
- On the display appear the words **SAR E d**

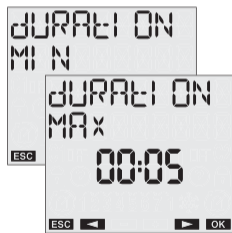

PROGRAMME OPTIONS Menu

This function allows programmed switchings to be impeded, discriminating them by typology, without having to cancel them from memory.

It is possible to:

- disable on/off programmes
(SWI ECT)
 - disable impulse programmes
 - disable cycle programmes
 - disable the holiday period programme
(HOLI DAY P)
 - disable individual day holiday programmes
(HOLI DAY d)
- choose SETTINGS PROGRAM using keys **"C1"** and **"C2"**
 - confirm with **"Ok"** .
 - choose channel **"C1"** or **"C2"** on which to work (choice only available for memo DW2 and memo Y2)
 - confirm with **"Ok"**.
 - the status is shown on the display for each type of switching (enabled or not)

- scroll the various types of programmings using keys **"C1"** and **"C2"** and press key **"Ok"** to access modification of the selected parameter
- once in modify, choose keys **"C1"** and **"C2"** if you want to enable or disable the switchings
- press **"Ok"** to confirm
- On the display appear the words
SAR E d

Note: this function allows one (or more than one) type of programme to be excluded from automatic operation.

PIN Menu

It is possible to set a protection code to stop anyone from working on the instrument.

The pin code is a number composed of 4 digits which may assume values from 1 to 4.

To set the pin code:

- choose SETTINGS PIN using keys **“C1”** and **“C2”**
- confirm with **“Ok”**.
- the four digits composing the current pin code are displayed (0000 corresponds to an inactive pin)
- confirm with **“Ok”**.
 - choose MODIFY and press **“Ok”** to insert the new pin code. Use keys **“C1”** and **“C2”** to enter the digits composing the code one by one and **“Ok”** to confirm them
 - choose RESET should you wish to deactivate the pin code request
- press **“Ok”** to confirm

- on the display appear the words **SAFE** (**DELETED** in the case of reset)

If the pin code request is active, about 3 minutes after the last time the keypad is pressed, keypad lock is activated. At this point pressing on the keypad again leads to a request to enter the pin code.

To unlock the instrument simply enter the pin code according to this rule:

- key **“↵”**: 1
- key **“C1”**: 2
- key **“C2”**: 3
- key **“Ok”**: 4

For example:

pin: 3411 **“C2”** **“Ok”** **“↵”** **“↵”**

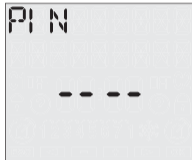

RESET SETTINGS Menu

This option resets all settings relative to:

- date format
- automatic change DST/CET
- minimum and maximum time between two casual switchings
- programme options
- pin code

To reset the settings:

- choose SETTINGS RESET using keys **"C1"** and **"C2"**
- confirm with **"Ok"** .
- confirm again with **"Ok"**
- on the display appear the words `WORKED`

The factory values are reloaded thus:

Date format	dd--mm--yy
Change DST/CET - change summer time - change winter time	automatic Last Sunday of March at 02:00 Last Sunday of October 03:00
Casual programme - minimum period - maximum period	1 minute 5 minutes
Request PIN	0000 - disactivated

METER MENU

The instrument is equipped with a function which allows load use to be calculated on a certain channel.

The counter has a range from 0 to 99999 hours. It resets automatically once the maximum limit is reached.

To display the meter:

- press key **"←"** to enter the menu
- choose the HOUR CNT option using keys **"C1"** and **"C2"** and press **"Ok"** to confirm
- using keys **"C1"** and **"C2"** choose the output concerned (choice only available for memo DW2 and Y2 memo) and press **"Ok"** to confirm. The total working hours are displayed,
- by pressing key **"Ok"** you access the possibility to reset the meter: once again press **"Ok"** to confirm or **"←"** to exit without resetting.

Note: in this way in the case of dual relay instruments it is possible to reset an individual meter which is not possible if the meter is reset from the "reset menu".

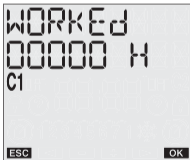

RESET MENU

It is possible to restore the initial status of the instrument using the reset function. 4 different resets are available:

- reset settings: cancel all the entered settings
- reset programmes: cancel all the saved programmes
- reset meter: reset the working hours meter
- reset all: reset settings+ reset programmes + reset meter

To perform a reset:

- press key “←” to enter the menu
- choose RESET using keys “C1” and “C2” and press “Ok”
- using keys “C1” and “C2” choose one of the resets listed above and press “Ok”
- press “Ok” to confirm

To perform a complete instrument reset, restoring the instrument to factory conditions, you need to use a pointed object to press key “R”. In this way all the settings carried out are cancelled and the initial conditions restored.

IR INTERFACE

The instruments of the memo series are equipped with an IR interface which allows programmes to be changed over between instrument and dedicated remote control easily.

Attention: IR interface is activable if the instrument is supplied by main AC power only.

In this way it is possible, for example, to carry out programming on an instrument and then copy it onto the remote control and duplicate it on the other instruments, without the necessity of redoing step-by-step programming.

The remote control is not supplied but may be purchased separately as an accessory:

Code	Model	Description
VE345500	memo.RC1	IR Italy remote control
VE366100	memo.RC2	IR Eng/Fra/Deu/Esp remote control

There are two basic functions in this working mode:

- **COPY**: allows the programmes to be transferred from a clock in the memo series to the remote control
- **PASTE**: allows the programmes to be transferred from the remote control to one (or more than one contemporarily) clock in the memo series.

Copy function

To transfer a programme from the clock to the remote control it is necessary to:

- generate a programme on the clock using the traditional method (see "Automatic programming")



3 seconds

- activate the receive mode on the remote control (in order to do so see the relative instructions sheet)

- activate transmission to the clock, for **3 seconds** holding the "Ok" key down

On the display appear the words

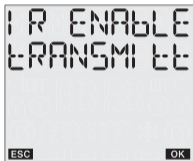

- once again press the key "Ok" to confirm start of the transmission or the key "←" to cancel the transmission.



- during transmission on the display appear the words DATA OUT (on the remote control display DATA IN) and the remote controls emits "beeps". At the end appear the words TRANSMI TE DONE.

Note: during transmission keep the remote control pointed towards the front of the instrument to facilitate transmission. Any problems with transmission are notified by the words RECEIVER FAILED on the remote control display.

Paste function

To transfer a programme from the remote control to one or more memo clocks, it is necessary to:

- connect the memo clock to the mains

- press key "R" to reset the instrument and activate receipt mode. On the display are shown the words



- activate transmission on the remote control and choose which programme to send (see instructions relative to the remote control)

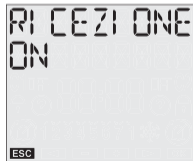

- during transmission on the display appear the words DATA IN (on the remote control display DATA OUT)

and the remote controls emits “beeps”.
At the end appear the words
TRANSMISSION DONE.

Note: during transmission keep the remote control pointed towards the front of the instrument to facilitate transmission. Any problems with transmission are notified by the words RECEIVER FAIL on the clock display.

At this point the programmes and the date and time settings are transferred to the instrument and it is ready to operate with the transferred parameters.



BATTERY REPLACEMENT

When the battery charge level drops below a certain threshold, on the first line of the display appear the words BATTERY. In this case replace the battery as soon as possible.

To replace the battery:

- disconnect the mains
- remove the battery slot cover, turning it anti-clockwise
- replace the battery and remount the cover, turning it clockwise
- connect the power supply

In order not to lose programming and the performed settings it is necessary to make sure that no more than 60 seconds pass between extracting the flat battery and inserting the new one.



**Only use CR-2032 type batteries.
Dispose of the used batteries observing the laws in force in relation to the disposal of hazardous waste.**

REFERENCE STANDARDS

Compliance with Community Directives

2006/95/EC (Low Voltage)

2004/108/EC (E.M.C.)

is declared in reference to the harmonized Standards

- **EN 60730-2-7**



Vemer S.p.A.

I - 32032 Feltre (BL) • Via Camp Lonc, 16
Tel +39 0439 80638 • Fax +39 0439 80619
e-mail: info@vemer.it - web site: www.vemer.it