

Televés®



T.OX SERIES

EN MUX DVBS2 - QAM CI Twin
MUX DVBS2 - COFDM CI Twin

Refs. 564301
564401

User manual

MUX DVBS2 - QAM/COFDM CI Twin

Contents

1. Technical specifications	5
2. References' description	8
3. Installation	9
3.1. Wall mount	9
3.2. 19 inch rack	10
4. Elements' description	11
4.1. Introduction	11
4.2. Power Supply Unit	12
4.3. Amplifiers	13
4.4. Programming Unit	14
5. Instructions for use	15
5.1. Standard menu	15
5.2. Extended menu	20
5.3. Saving parameters	25
6. Device control	25
7. Example installation	27
8. Rack-mount standards	28
9. Standards for wall mounting cabinets	30

Televés

1. Technical specifications

1.1. MUX DVBS2-QAM CI Twin Ref. 564401, MUX DVBS2-COFDM CI Twin Ref. 564301

Satellite demodulator	Input frequency	MHz	950 - 2150	Through losses (typ.)	dB	< 1.5	
	Symbol rate	Mbaud	2 - 45	Modulation	DVB-S2	QPSK, 8PSK	
	Frequency steps	MHz	1		DVB-S	QPSK	
	IN/OUT connectors	tipo	"F" female	FEC inner code	LDPC	9/10, 8/9, 5/6, 4/5, 3/4, 2/3, 3/5, 1/2	
	Input impedance	ohm	75	FEC outer code		Bose-Chaudhuri-Hocquenghem	
	LNB powering	Vdc/KHz	13-17- OFF / 22KHz (ON-OFF)	Roll-off factor	%	20, 25, 35	
	Satellite selection (DiSEqC)		A, B, C, D	Return losses (min.)	dB	10	
QAM modulator (Ref. 564401)	Modulation format	QAM	16, 32, 64, 128, 256	Scrambling		DVB ET300429	
	Symbol rate	Mbaud	1 - 7.2 (select.)	Interleaving		DVB ET300429	
	Roll-off factor	%	15	Bandwidth (max.)	MHz	8.3	
	Block code		Reed Solomon (188, 204)	Spectral inversion (selectable)		Normal / Inverted	
OFDM modulator (Ref. 564301)	Modulation format		QPSK, 16QAM, 64QAM	Scrambling		DVB ET300744	
	Guard interval		1/4, 1/8, 1/16, 1/32	Interleaving		DVB ET300744	
	FEC		1/2, 2/3, 3/4, 5/6, 7/8	Cell_id		Selectable	
	Bandwidth	MHz	7.8	Spectral inversion (selectable)		Normal / Inverted	
RF output	Output frequency (selectable)	MHz	46 - 862	Through losses (typ.)	dB	< 1.5	
	Frequency steps	564401	KHz	250	Return losses (typ.)	dB	> 12
		564301		166 - 125 (select.)			
	Max. output level (select.)	dB μ V	80 \pm 5	IN/OUT connectors	tipo	"F" female	
Attenuation (selectable)	dB	> 15	Output impedance	ohm	75		

General	Consumptions @ 24Vdc (with signal)*	mA	530 (564301) 540 (564401) => (LNB not powered/ CAM not inserted) 630 (564301) 640 (564401) => (LNB not powered/ CAM inserted) 880 (564301) 890 (564401) => (one LNB powered/ CAM inserted) 1130 (564301) 1140 (564401) => (two LNB powered/ CAM inserted)
	Protection level	IP	20

* Consumptions are measured with input signal.

The consumption indicated for CAM and LNB are highest; in any case, depend on the type of CAM and LNB for each facility.

The technical specifications are defined for an ambient temperature of 45 °C (113 °F). For higher temperatures forced ventilation will be used.

1.2. Broadband amplifier technical specifications

Amplifier Ref. 5575	Frequency range	MHz	46 ... 862	Connector	tipo	"F" female
	Gain	dB	44 ± 2.5	Powering	V===	24
	Regulation margin	dB	20	Consumption @ 24 Vdc	mA	450
	Output level (60 dB)	dBµV	105 (42 CH CENELEC)	Test socket attenuation	dB	-30
Amplifier Ref. 451202	Frequency range ⁽¹⁾	MHz	47 ... 862	Connector	type	"F" female
	Gain ⁽¹⁾ (selectable)	dB	40 - 53 (select.)	Mains	V~ / Hz	196 - 264 / 50-60
	Output level (max.) ⁽¹⁾	dBµV	129 (DIN 45004B)	Max. power	W	16
	Frequency range ⁽²⁾	MHz	5 ... 30	Test socket attenuation	dB	-20
	Gain (typ.) ⁽²⁾	dB	20/ -3			
Output level (typ.) ⁽²⁾	dBµV	129/ --- (DIN 45004B)				

(1) Forward path

(2) Return path (active / passive)

1.3 Power Supply Unit technical specifications

PSU Ref. 5629	Mains voltage/frequency	V~ / Hz	196 - 264 / 50-60	Total maximum current (OUT1 + OUT2)	A	5 (24V $\overline{=}$)
	Output voltage	V $\overline{=}$	24	Maximum current per output		4 (24V $\overline{=}$)

1.4 Block diagram

EN

Ref. 564401

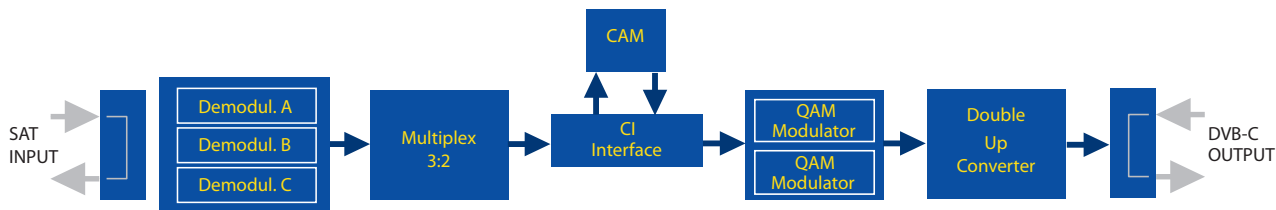

Ref. 564301

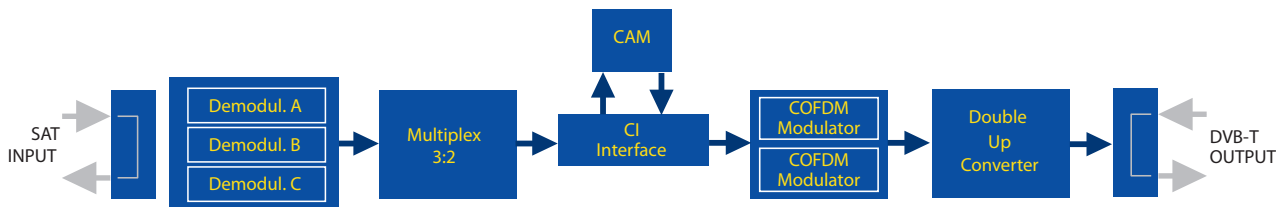

2 References' description

Product range		Accessories	
564401	T.0X DVB-S(2) / QAM CI TWIN MUX 3TP(2SAT):2C	7234	Programming Unit
564301	T.0X DVB-S(2) / COFDM CI TWIN MUX 3TP(2SAT):2C	5071	T03-T05-T.0X Wall mounting rail L=50 cm
5575	T.0X Broadband Amplifier 44dB 120dB μ V	5239	T03-T05-T.0X wall mount rail (12 units + PSU), L= 56 cm
451202	Amplifier DTKOM 5-30PD47-862	5301	19 inch sub-rack frame
5599	T.0X Headend Manager CDC-IP	507202	T.0X Lockable cabinet with Ventilation Unit (7 Modules + PSU)
555901	T.0X Headend Manager CDC-IP GSM	4061	75 Ohm DC-Block terminal load
5629	T.0X Power Supply Unit 24VDC/5A	4058	75 Ohm terminal load
		422601	T05 to T.0X Power interconnection lead L=40 cm
		422602	T05 to T.0X Management interconnection lead L=40 cm
		422603	Control Bus Jumper (100 cm)
		5673	Blank plate

3 Installation

3.1 Wall mount

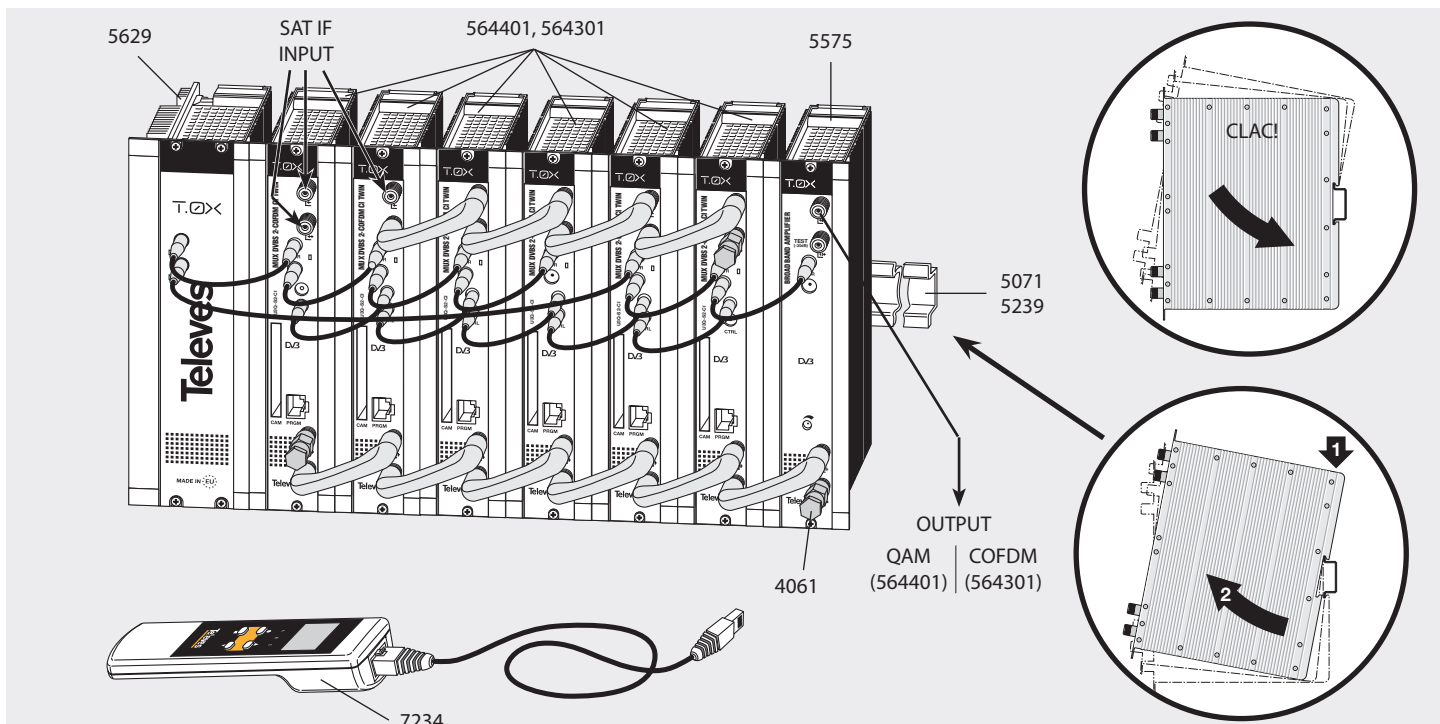

EN

NOTE: The use of both PSU power outputs is recommended to balance the consumption. For example, 4+3 or 3+4.

3.2 19 inch rack-mount

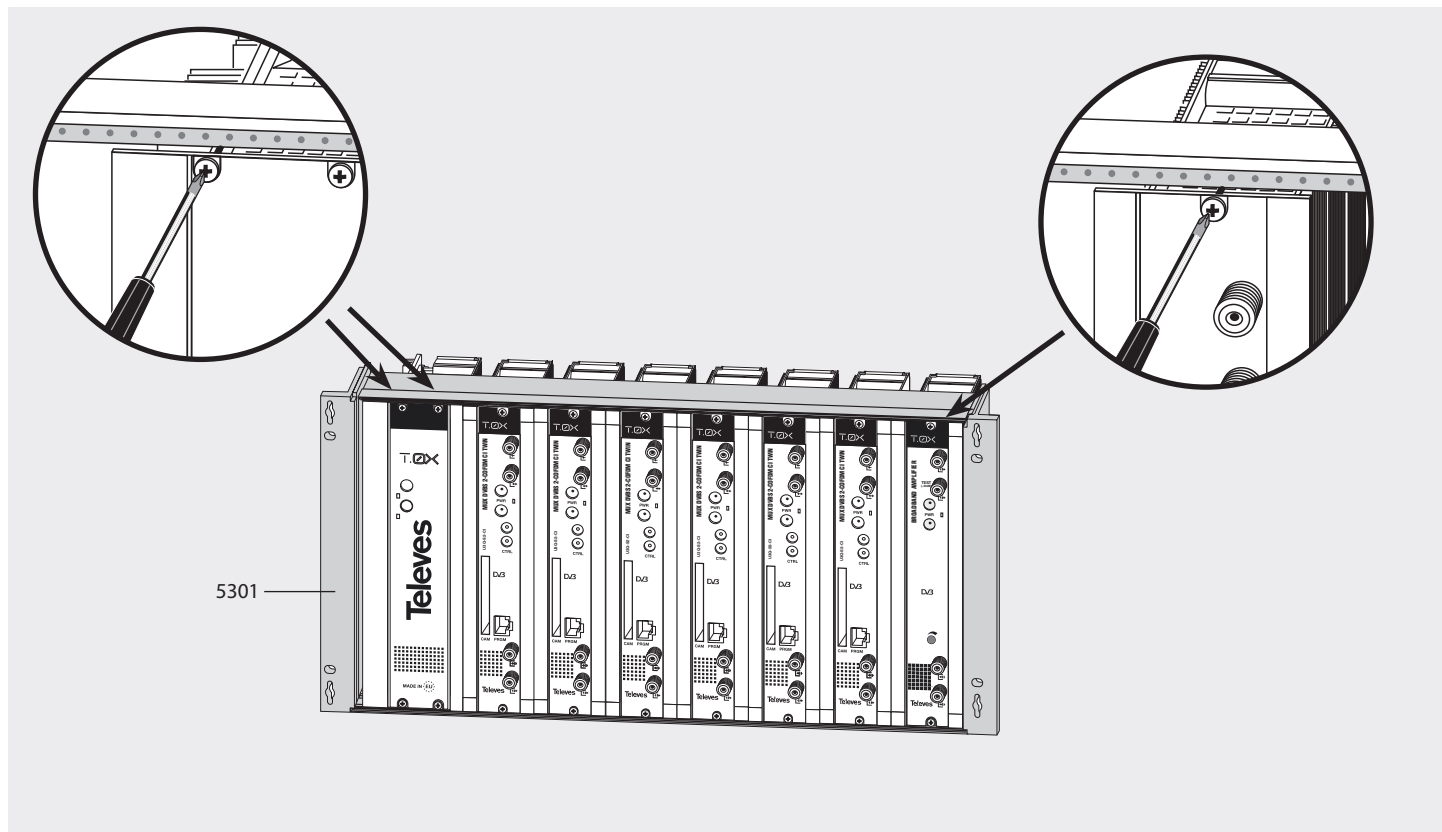

4 Elements' description

4.1 DVBS2 - QAM CI Twin (564401) / DVBS2 - COFDM CI Twin (564301)

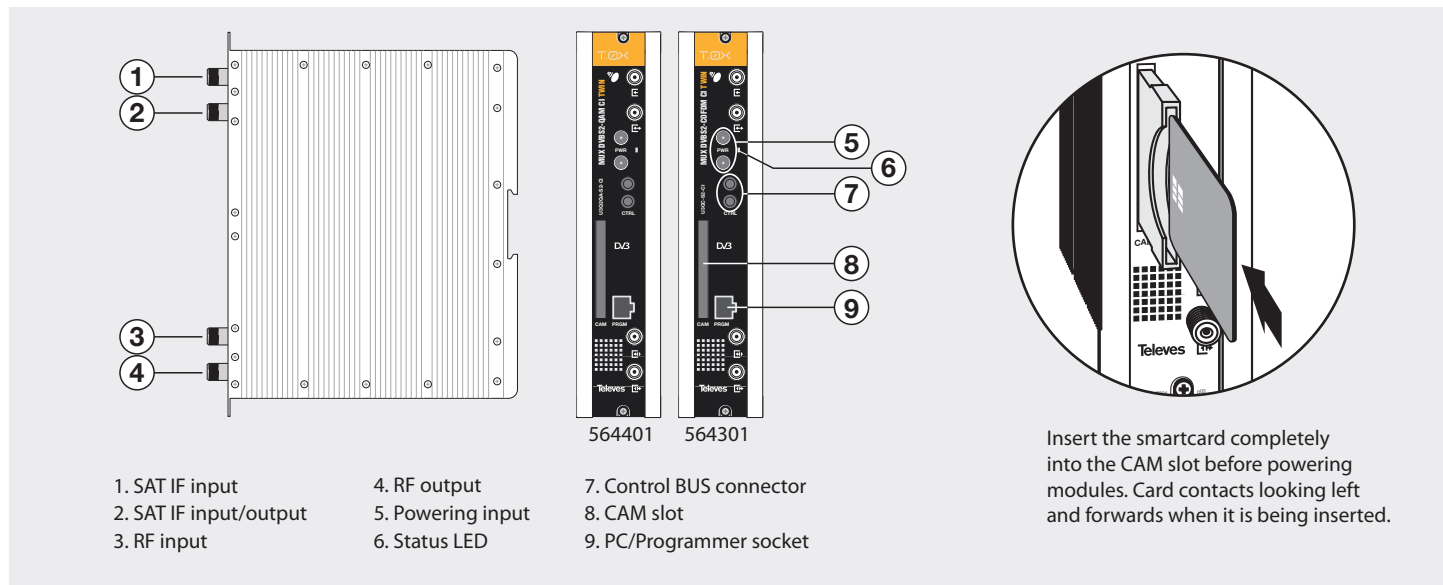

- 1. SAT IF input
- 2. SAT IF input/output
- 3. RF input
- 4. RF output
- 5. Powering input
- 6. Status LED

- 7. Control BUS connector
- 8. CAM slot
- 9. PC/Programmer socket

Insert the smartcard completely into the CAM slot before powering modules. Card contacts looking left and forwards when it is being inserted.

The multiplexer can demodulate up to three DVBS or DVBS2 signals from one or two satellite IF inputs. The user selects which services will be transmodulated in each of the two available outputs. Two transport stream are created, which are then modulated in QAM (564401) or COFDM

(564301) format and converted to their respective output channels using an agile up-converter.

A Common Interface slot is available. A conditional access module (CAM) can be inserted to descramble output services.

To configure the multiplexer operating parameters (input frequency, output channel, modulation format and adaptation of services) the universal programming unit (ref. 7234) or the TSuite software can be used.

4.2 Power Supply Unit

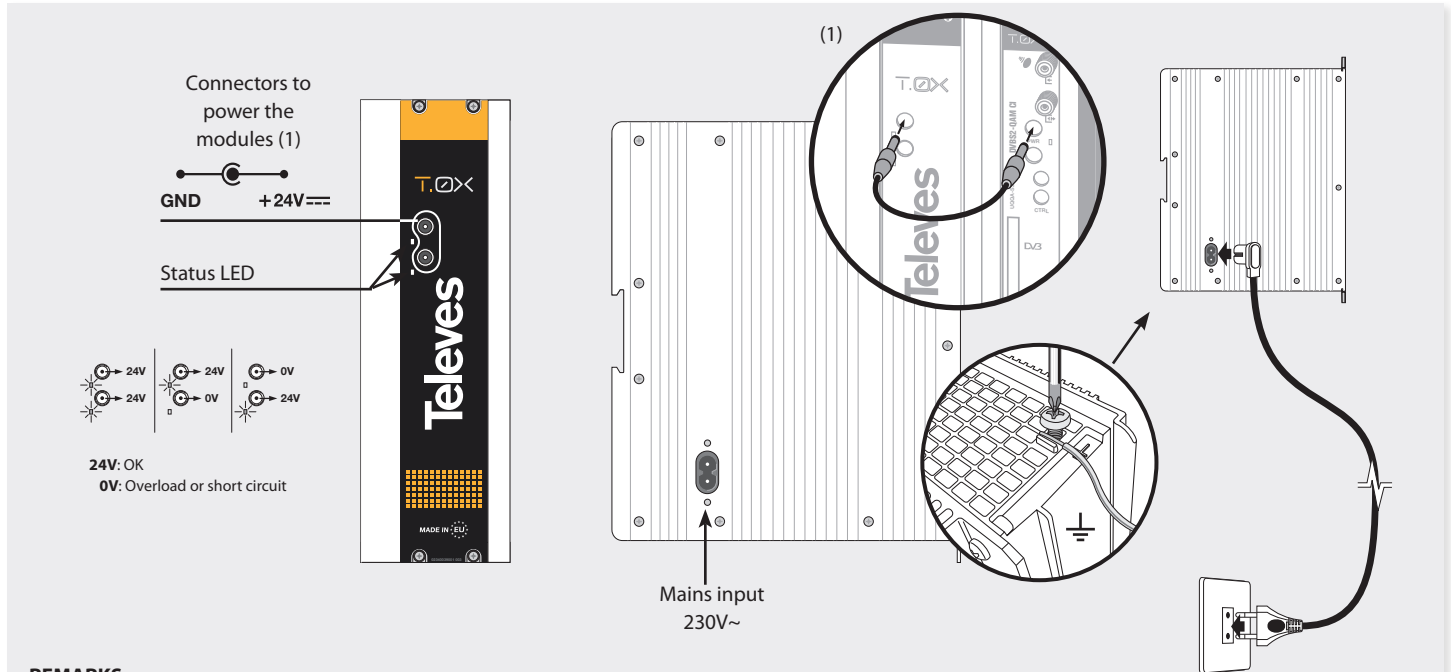

REMARKS

- The power supply can power up to a maximum of 7 modules with CAM, and being active only 2 LNB feeds of the assembly of seven multiplexer.
- When a CAM is inserted, it is assumed that the multiplexer' consumption increases about an average of 70 mA (since CAM consumptions in the market can vary between 20 & 100 mA). Each LNB feed activated increases the multiplexer' consumption about 250 mA (also depending on the LNB model).
- The two PSU power outputs must be used in order to balance their consumptions in a chassis, therefore whenever the demand of power exceeds 4A (max. current for each output), it is necessary to distribute it between the two powering outputs of the PSU (for example: 4+3 modules; 3+4 modules).

4.3 Amplifiers

OPTION "A" - 5575

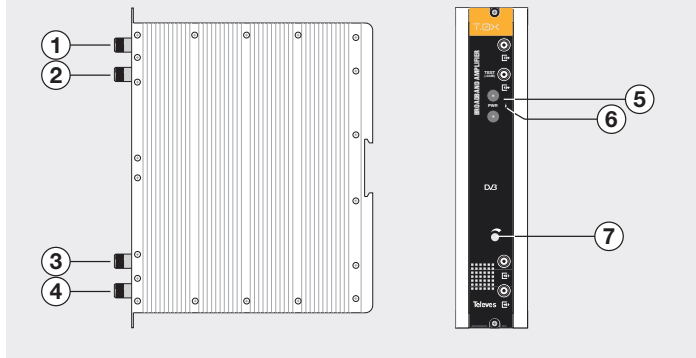

- 1. RF output
- 2. Test output
- 3. RF input 1
- 4. RF input 2
- 5. Powering input
- 6. Status LED
- 7. Attenuator

It features two input connectors, to allow mixing of channels coming out from two different systems. If only one of the inputs is used, it is recommended to load the unused input with a 75 ohm terminator, ref 4061.

On its front upper part, it features a test socket (-30 dB) as well as the RF output connector.

As the rest of T.OX units, this amplifier is powered via the 24 Vdc power BUS.

OPTION "B" - 451202

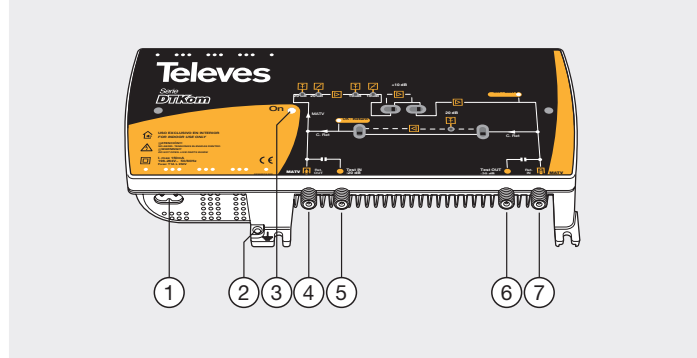

- 1. Mains input (196- 64 V~ 50/60 Hz)
- 2. Ground terminal
- 3. ON/OFF LED
- 4. MATV input / Return channel output
- 5. MATV input test
- 6. MATV output test
- 7. MATV output / Return channel input

Broadband amplifier in shielded zamak chassis, with gain configured by the installer.

4.4 Programming Unit PCT 5.0

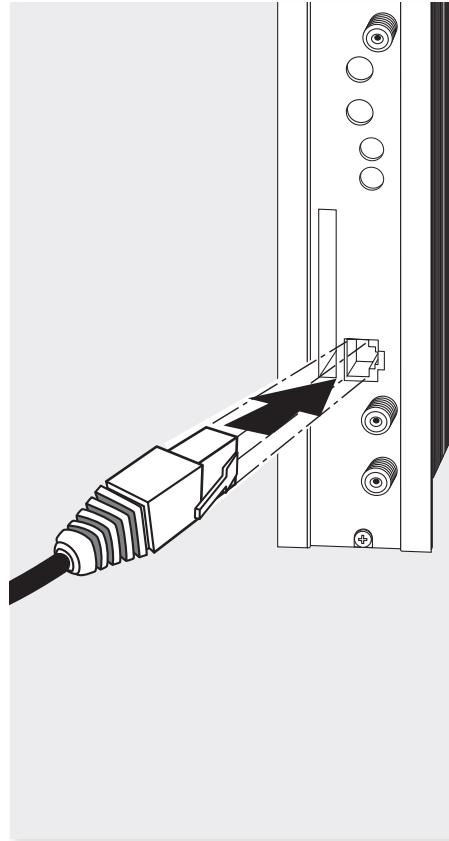

The programming unit features 4 buttons:

●	(short press) - Selection of parameter (positioning of the cursor).
▲-▼	Modification of the parameter chosen by the cursor (flashing).
■	(short press) - Change menu.
●	(long press) - Change between Principal and Extended menus or reset parameters in certain menus.
■	(long press) - Save changes to memory
● + ▲	Cloning menu.
■ + ● + ▲	Increases the contrast of the screen.
■ + ● + ▼	Decreases the contrast of the screen.

5 Instructions for use

Connect the programming unit to the front socket of the module ("PRGM").

At first, the controller's firmware version will appear:

```
PCT firmware
version
-----
U:5.3
```

Next, it is displayed the firmware version of the corresponding module:

```
Unit
Firmware
version:
1.00.00016
```

5.1 Standard menu

5.1.a Input menu

The multiplexer consists of 3 demodulator (called **A**, **B** and **C** in the menus). The signal to be demodulated comes from one of the two F connectors, since the second input can be configured either as a loop-through of the first one, or as an independent input (see menu 5.2b). In the latter case, demodulator **A** receives signal from connector 1 while demodulator **B** and **C** receive signal from the second connector. The module is able to provide power voltage to 2 LNB through their input connectors whenever they are configured as independent inputs, as well as a selection of satellite using DISEqC commands.

The first standard menu allows to select the **input frequency** and the **symbol rate** of each one of the 3 input channels.

```
A▶INPUT
Freq:1922MHz
27.500 Kbaud
Enable
```

To modify the frequency, press ● until the desired parameter starts to flash. Then change its value using keys ▲ and ▼.

The range of allowed input frequency values is **950-2150 MHz**, whereas the range for symbol rate is 2 to 45 Mbaud. Detection of both DVB-S2 and

DVB-S signals is automatic.

These parameters will be active when the option "Enabled" is selected

These parameters are only operational when you select the option 'Enabled'. If you switch from 'Enabled' to 'Disabled' the input will not be considered.

Whenever the selected input is locked it will be shown a symbol on the right of the Input field, as follows:

```
A▶INPUT ●
Freq:1922MHz
27.500 Kbaud
Enable
```

In the event of a "short circuit" in the input connector (LNB power enabled on any of both inputs), a LED on the front of the module will flash until the condition disappears.

5.1.b QAM modulation menu (only to the Ref. 564401)

The following main menu allows selecting, for each of the two outputs, the parameters of output QAM modulation:

```

1▶QAM
Mod: 256QAM
IQ: normal
Baud:6.900Mb

```

The available options for this menu as well as their possible values are:

- 16QAM, 32QAM, 64QAM, 128QAM and 256QAM for QAM modulation order.
- The IQ parameter is the modulation format selection ,and can be set to "normal" or "inverted".
-

Note: *The bandwidth required depends on the number of services present on the output (those selected as ON or DCY, see menu of services).*

5.1.b.1 COFDM1 modulation menu (only to the Ref. 564301)

In the following main menu you can select, for each of the two outputs 1 or 2:

- Modulation bandwidth 7 or 8 MHz
- Modulation order: QPSK, 16QAM, 64QAM.
- Guard interval GI (1/4, 1/8, 1/16, 1/32) and FEC of the modulation (1/2, 2/3, 3/4, 5/6, 7/8).

```

1▶COFDM
8MHz 64QAM
GI:1/8
FEC:3/4

```

5.1.b.2 COFDM2 modulation menu (only to the Ref. 564301)

This menu allows to select, for each of the two outputs:

- **Cell-id** parameter (cell identifier) of the COFDM modulation.
- **Normal/Inverted** mode of the COFDM output.

```

1▶COFDM
Cell_id:
0x0000
IQ: normal

```

Note: *The bandwidth required depends on the number of services present on the output (those selected as ON or DCY, see menu of services).*

5.1.c Output menu

Next main menu shows the output frequency/channel, the output level control and the output mode selection, for each of the outputs.

```

2▶OUTPUT
Ch:C21
<474.00MHz>
Lev:99 Norm.

```

```

2▶OUTPUT
Freq: 474.00
Level: 99
Output:Norm.

```

To change a parameter press the key ● until the desired parameter flashes. Then the value of this field can be changed by means of the keys ▲ and ▼.

The output frequency ranges from 46 to 862 MHz. The output level control permits values within a scale from 00 up to 99.

Choices for output mode are the following:

- **Norm** Standard output mode.
- **CW** Continuous wave mode. It is generated a carrier on the selected frequency.
- **OFF** No output is generated.
- **NULL** It is generated a modulation with null packets.

5.1.d Identifiers menu

Since each of the output *transport stream* is formed from three inputs, it is necessary to specify the identifiers of it.

In this menu the user specifies the desired values for: *transport_stream_id* (*ts_id*); *network_id* (*n_id*) and *original_network_id* (*on_id*).

```
1▶IDs
ts_id:0x04fc
n_id: 0x055f
on_id:0x055f
```

5.1.e Services menu

This menu shows the list of transport stream services at the input. Each time the user selects a new input transport stream, the unit performs a search for services.

During the process, the unit will show the message below displaying the number of channels as soon as they are being found:

```
A▶SERVICE
Scanning:003
```

Once the search has completed, it is displayed a list of services. Each service is part of a list containing all services found in the 3 input channels. The information available in this screen is the following:

```
A▶SERU  ?▶?
7/56  23/50
PLANETE NO
LIMIT  ON1
```

- **Identifier of the input** to which the service belongs: A, B or C.
- **Status of the encryption of the service**, for both input and output of the module. When the service is set to ON/OFF, only is displayed the input status. When the service is configured as DCY, it is displayed its status before and after passing through the CAM.

Additionally, on the upper right corner of the window it is indicated the status of the service on the input (encoded or plain), for those services set to ON and DCY:

- ? Scrambled service in the input: a) if set to OFF, it does not pass to the output; b) if set to ON, it exits without going through the CAM.
- △ Free service in the input: a) if set to OFF, it does not pass to the output; b) if set to ON, it exits without going through the CAM.
- △▶△ Free service in the input, and free service

in the output (configured as DCY).

- ?▶△ Scrambled service in the input, and free service in the output (configured as DCY).
- ?▶? Scrambled service in the input, and scrambled service in the output (configured as DCY).

- **Service's order** within the list, and total number of services found from all inputs (see figure, where 7/56 indicates that it is the index 7 of a list containing 56 services).
- **Statistics.** A value indicating the occupation of this service at the output as well as the percentage that remains free.

It is displayed as N/M (23/50 in the figure), where:

- » **N** indicates the capacity needed at the output to transport this service. If this service is ON, it indicates the percentage of the output occupied by the service, this is, percentage of the whole bit rate occupied by this service if it is enabled to pass through.
- » **M** indicates the percentage of the output that still remains available to transport additional services. This value is updated if you change the status of a service (when switching to ON, the output's occupation is subtracted automatically - switching to OFF it is added) thus giving a good estimate of available capacity before saving the configuration. It is said an estimate because its value is increased or decreased according to what would occupy the complete service (without considering PID filtering, even when selected previously). Once saved the configuration, this value will

become the actual value to take into account, which may vary slightly from the estimate.

Note: When the number of services exceeds 100, it is displayed the list of services and occupation alternately, due to the limited space on the programming unit.

- **Service name**
- **Service filtering status.** Choices are OFF, ON1, ON2, DCY1, DCY2.
 - » **ON1, ON2:** The service passes straight forward to the output 1 or 2, without changes.
 - » **OFF** The service is not allowed to go through to the output.
 - » **DCY** The service goes through to the output 1 or 2 and also request its unscrambling to the module of conditional access if it is available. A sign of admiration (!) will appear in this condition, when for the position in which the CAM is situated is impossible to decrypt it. If the CAM is located at the output 1 DCY2 option will not be allowed.

There are two ways to move from one service to another:

- I. First, by short presses on the ● key, move the cursor to the service name; then use keys ▲ and ▼ to move up/down among services. When using the ▲ key from the last service of one of the inputs, it is automatically displayed the first service of the following input and amended the top identifier (A, B, C) in order

to indicate, at all times, which is the input that provides the current service.

- II. Direct access to the services of a particular input by selecting the identifier of one of the A/B/C inputs, and again making use of keys ▲ and ▼. Thereby, by pressing key A or B it is accessed the first or last service of the input, respectively. Proceeding this way, once located the services of the desired input, just place the cursor on the name of the service to get access to the rest of the list. If any input is not available, the screen will display "Unlock" when trying to access its list of services.

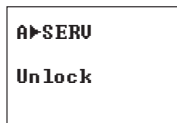

Within the service menu, you can get access to the advanced **PID menu** by a long press on ● key (more than 2 sec). This option shows the list of PID belonging to the service that was displayed on the standard menu.

Be aware that it should be used carefully and may need to know the characteristics of the input transport stream for proper configuration.

This is because the PIDs of a service are subject to changes, and if this happens the values set in this menu may no longer be valid and therefore unwanted behaviors can occur at the output.

Come back to the service menu by a long press on ● key.

5.1.e.1 PIDs menu

To access this menu, within the service menu make a long press on ● key. Make again a long press on ● key to return to service menu.

Choose a service and then select the action to be carried out with its PIDs.

The main use of this menu is to remove an audio streaming (for those services that have more than one audio) or other service information (teletext, private data, ...) so that you can reduce the output occupation.

In the case of having a CAM module, it is possible to reduced the capacity used, and allowing sometimes increasing the number of services that can be unscrambled:

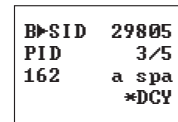
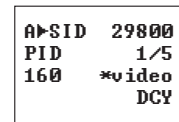

The available information in this menu is the following:

- **Identifier of the input** from which comes the service (A, B, C).
- **Identifier of the service** to be configured (SID Service id).
- **PID index** and total number of them available in the service (in above examples: 1/5 and 3/5).
- **PID identifier** (in above examples: 160 and 162).

- **Description of the PID function:**

- » **Video** Service video streaming. It displayed on the screen with the word video.
- » **Audio** Audio streaming. It displayed on the screen with a letter followed by 3 characters that provide additional information about this audio. In most of the cases they identify the language, but not always is the case. As an example: "spa" would mean Spanish language.
- » **Other** This way are displayed the PIDs not corresponding to video and audio.
- » In some PIDs is displayed an asterisk (*) sign. This means that this PID contains information about PCRs (*Program Clock Reference*).

- **PID filtering status:** ON, OFF, DCY.

Not all options are always available. If a service is set OFF, all its PIDs are OFF and therefore it will not possible modify their values.

If a service is set ON, it will be possible select PID filtering ON and OFF, but never DCY.

DCY PID filtering option is available only for those services set DCY.

PIDs marked with * cannot be set OFF since they contain PCR information of the service which is indispensable for the correct decoding of the output.

- » **ON** It passes to the output without any request of unscrambling to the CAM module.

- » **OFF** It is not allowed to pass to the output
- » **DCY** It passes to the output and requests unscrambling to the CAM module, if available.

5.1.f Measure menu 1

This menu provides an indication of the input **signal quality** by estimating both *C/N (dB)* and *Link margin (dB)*.

```
A▶MONITOR >>
C/N:14.1dB
L.M.: 7.7dB
```

5.1.g Measure menu 2

This menu shows messages related to adaptation and deleting of services configured in the SERVICES menu for each of the two outputs.

If all input are unlocked, no message is displayed.

Possible messages to be displayed are the following:

- **Occupation**

Occurs when the adaptation is being carried out without error, and shows the user the percentage of bit rate that is occupying at the output.

It also shows the peak reached, which can be reset by pressing on ● key. Occupancy rates shown on this screen are always actual percentages; ie, only those that are the result of the last recording made by the user. In no case it is considered the value of occupation "estimated" from changes of configuration not saved, as done in section 5.1.e *Service Menu*.

```
1▶MONITOR
Occupancy:
76%
Max:80%
```

```
2▶MONITOR
Occupancy:
90%
Overf low!
```

- **Overflow**

This message is displayed when it is detected that the services selected exceed the bit rate available at the output. Therefore, the user must delete some of selected services in order to ensure a correct operation.

Occupancy values beyond 82% are not recommended. This is so since the occupancy indication is an instant measure. If this value is exceeded due to the variability of the input transport stream, it could cause occasional overflows which would degrade the quality of the output image.

This is a read only menu.

5.2 Extended menu

To access this menu make a long press on ● key (more than 3 sec). It displays a number of less frequently used configuration options, called extended menus.

Be aware that the same key is used to switch between “Service menu” (see section 5.1.e) and “PIDs menu” (see section 5.1.e.1).

5.2.a.1 Configuration menu 1 (Ref. 564401)

The first extended menu allows selecting the following parameters:

- **Dir CDC**

Address of the device that allows selecting it via a control BUS connected to the Headend Control Module (CDC). With this menu you can change the address of the unit on the remote control bus (when the unit is connected to a headend control module via its communications BUS). It is the responsibility of the user to ensure that each unit has been assigned a unique address on the bus, or the units will not communicate. The valid address range goes from 1 to 254 (which is the maximum number of devices controllable from a single headend controller module).

- **Frequency mode/Table of channels**

Using this menu, the user can select one of the

two modes available to program the output frequency. Choices are: a) By entering the channel frequency value, and b) by selecting the channel in one of the following tables:

- CCIR N.Z.Ind • South Africa
- Russia (OIR) • Italy)
- China Taiwan • Poland
- Ireland • France
- Chile M/N • Australia

```
▶CONFIG >>
CDC Adr: 001

CCIR N.Z.Ind
```

```
▶CONFIG >>
CDC Adr: 001

Frequency
```

5.2.a.2 Configuration menu 1 (Ref. 564301)

The first extended menu allows selecting the following parameters:

- **Dir CDC**

Address of the device that allows selecting it via a control BUS connected to the Headend Control Module (CDC)

With this menu you can change the address of the unit on the remote control bus (when the unit is connected to a headend control module via its communications BUS). It is the responsibility of the user to ensure that each

unit has been assigned a unique address on the bus, or the units will not communicate. The valid address range goes from 1 to 254 (which is the maximum number of devices controllable from a single headend controller module).

- **Selection of the output frequency step**

There are two options for each of the two outputs:

- » 166 KHz
- » 125 KHz

- **Frequency mode/Table of channels**

Using this menu, the user can select one of the two modes available to program the output frequency.

Choices are: **a)** By entering the channel frequency value, and **b)** by selecting the channel in one of the following tables:

- CCIR N.Z.Ind • South Africa
- Russia (OIRT) • Italy)
- China Taiwan • Poland
- Ireland • France
- Chile M/N • Australia

```
▶CONFIG >>
CDC Adr: 001
Step1:166KHz
CCIR N.Z.Ind
```

```
▶CONFIG >>
CDC Adr: 001
Step2:166KHz
Frequency
```

5.2.b Configuration menu 2

This menu allows to select the number of unit inputs, as well as controlling the LNB powering and the DiSEqC command for each one of the enabled inputs.

Although the product has 3 demodulators A, B and C, the signals can come from a single input port (in which case the second port functions as an input loop-through), or from the two input ports, in which case the signal distribution is done as follows:

- input port 1 to demodulator A
- input port 2 to demodulators B and C.

Choices are the following:

• Number of inputs LOOP-THROUGH

- » **ON** The second connector works as an output for the signal coming in through the first connector, and thus this signal is available for serving another module. Demodulators A, B and C receive the same signal.

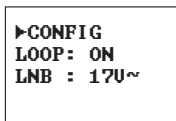

- » **OFF** This choice configures the second connector of the unit as an independent input, and therefore will supply the signal to demodulators B and C. This can

be applied either for demodulator A or demodulators B and C.

»

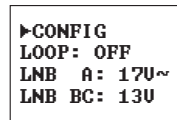
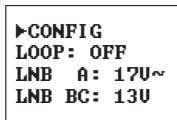

- » **LNB power voltage** Lets you select one of the four available satellites (A, B, C and D), by using DiSEqC commands whenever it is necessary (e.g. a multiswitch output). 0 Vdc; 13 Vdc; 13 Vdc+22 KHz tone; 17 Vdc; 17 Vdc+22 KHz tone.

Symbol ~ on the RCU screen means 22 KHz. If you choose option "0 volts" for the LNB, it disables any satellite selection.

5.2.c Temperature measurement menu

This menu shows the current measured temperature, and the peak in °C.

The maximum recorded temperature may also be reset by press and holding the ● (more than 3 sec).

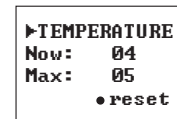

Operating temperature ranges are scaled from 0 to 10 in the following way:

- 0 to 6 Optimum temperature range.
- 7 to 8 High temperature range.
- 9 to 10 Too high temperature.

Should the temperature be out of the optimum temperature range, please provide adequate cooling to reduce it.

In case of using a wall mount cabinet, Ref. 5069, to accommodate these modules MUX DVBS2-QAM and COFDM CI, and the temperature was out of the optimum range in any module of the headend, make use of the ventilation unit Ref. 5334. To check whether this change is effective or not, reset the maximum recorded and then check again the temperature after a time deemed appropriate.

5.2.d Versions menu

This menu displays the firmware version for the unit as well as the one of the QAM/COFDM modulator.

```

▶VERSION
FW:2.02
Mod:2.00.30

```

5.2.e CAM menu

This menu lets you to configure the CAM for processing the Transport Stream, as well as if it is going to work in safe mode.

```

▶CAM CONFIG
POS:OUT
DCY SECURE:
ON

```

Choices are the following:

- **POS**

The CAM can be connected to process either the output of any demodulator, or the multiplexed transport stream. In the first option, only those services from the selected input will be unscrambled. In the second option, it will be unscrambled services from several inputs with the same CAM, provided that the CAM specifications and conditional access system allow to do it.

Possible options are:

- » **IN A** Can be unscrambled services from input A, only.
- » **IN B** Can be unscrambled services from input B, only.
- » **IN C** Can be unscrambled services from input C, only.
- » **OUT 1** Unscrambling of services from any input can be done, whenever they are present on output 1, share the same conditional access system and the CAM was able to support the modulated output baud rate.

- » **DCY SAFE** There are 2 possible status: ON (enabled) and OFF (disabled)
This choice configures the behavior of the module to face changes in the input transport stream.

Professional CAMs can process a given maximum number of PIDs to be decoded at the same time, and therefore the multiplexer has to be configured to work within these conditions.

But not always it is the case since the input transport stream can change, adding audio and video PIDs in some services, and, as a consequence, the number of PIDs sent to the CAM might exceed the maximum number it can process.

If this happens it might be possible a malfunction of the CAM due to its saturation at a given time.

- » **ON SAFE** When the user configure and saves a number of PIDs, the safe mode sets this number as the maximum of PIDs to be sent to the CAM.

Thereby, for new services coming into the unit, the CAM will let them to pass-through in ON status; unless it is a PID of a known type (audio or video) that replaces one of the same type that disappears, in which case is set to the same value it was the original one.

In the first case of the section 5.1.e.1, the new PID is set ON, and the user can set it to DCY if the CAM not becomes saturated. After saving this new configuration, the maximum number of safe PIDs is increased.

If the PID disappears again and reappears, it will always DCY.

- » **OFF SAFE** All PIDs that may appear “new” in the input transport stream, automatically change their value to that this service has in the “Services menu 5.1.e”.

Note: Avoid a CAM saturation is a responsibility of the user.

5.2.f CAM user interface menu (MMI)

This menu provides access to the user interface conditional access module (CAM), for example, to check versions or rights of the card.

```

▶CAM MMI
Press ● for
menu
  
```

Should not be connected any conditional access module (CAM), then it will be displayed the message "CAM unavailable".

5.2.g LCN menu

This menu lets you assign a LCN (*Logical Channel Number*) to the services that are present in each of the two outputs of the multiplexer.

This function allows an automatic ordering of services, in those receivers ready for it. If selected "0" as channel number, it means that no number is assigned to this service, and therefore it will be displayed: NO LCN.

```

1▶LCN
1/4
Fashion TU
N:0003
  
```

```

2▶LCN
3/4
Soyuz TU
NO LCN
  
```

On the upper of the display is displayed the index (order) of the current service and the total number of them at the output. Next is shown the service name.

Finally, on the last line is displayed the channel number (LCN) assigned.

There are a number of predefined LCNs for certain satellite services. If the selected service is one of them, the predefined LCN will be displayed on the left side, that will be automatically assigned to the service. In any case, the user can modify it if desired.

Note: *The user must avoid setting the same LCN for different services.*

When the unit detects that the LCN value shown is assigned to more than one service, it displays an exclamation mark (!) to the right of the value to indicate the user to assign a different value.

5.2.h Service_ids remapping menu

This menu allows configuring, in each of the two outputs, the output *service_id* value for each one of the services configured to ON/DCY.

Using this option you can change a service by

another previously OFF, and keep the same *service_id*, allowing a large number of receivers automatically detect the change without having the need to re-scan.

```

1▶SID 1/3
A. Direct
Start
10030▶00001!
  
```

On the upper of the display is displayed the index (order) of the current service and the total number of them at the output. Then is shown the input from which comes the service, followed by the service name.

And finally, in the bottom line of the screen, is shown the corresponding number with the *original service_id* and the *service_id* value at the output.

Note: *The user must avoid setting the same service_id for different services.*

When the unit detects that the *service_id* value shown is either assigned to more than one service or is the "0" value, it displays an exclamation mark (!) to the right of the value to indicate the user to assign a different value.

5.2.i LCN type menu

Not all receivers interpret in the same way the information provided by LCN (Logical Channel Number).

Some countries use some variation on the standard to be applied for this setting to work properly.

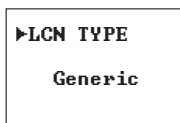

Available choices are: Generic, UK and Nordig

5.2.j Network identifier menu

You can set the network name to be inserted in the output channel. Since each of the inputs can come from networks with different names, it is not used any of these input network's names at the output, and therefore is the user who will be in charge to specify the desired name.

By default the network is called "TELEVES".

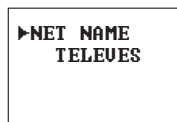

5.2.k PSI tables versions Menu

In each of the two outputs are allowed to set the version of the NIT and SDT output tables. The user can select a fixed version number between 0 and 31 or "AUT", in which case the unit automatically manages versions of tables.

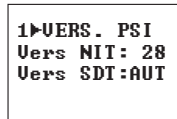

5.2.l Language menu

The next extended menu allows selecting the menu language (English / Spanish / Italian / German / French):

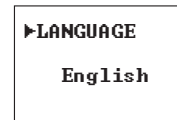

Make use of keys ▲ and ▼ to select language.

5.2.m. Default parameters

The last extended menu allows re turn to default parameters. To do this you must hold down ● key.

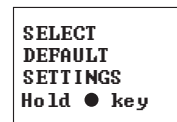

5.3 Saving parameters

After setting up the unit by means of the two menus available, main and extended, all data will be saved by pressing the button ■ for about 3 seconds.

The display shows:

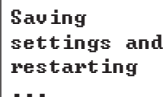

```
Saving
settings and
restarting
...
```

Do not remove the programmer before the message disappears from the screen.

If configuration data are changed but not saved, previous settings will be restored after about 30 seconds. Therefore all changes made would be canceled.

6. Device control

This version of modules allows configuration and monitoring via a PC, both locally and remotely.

a. Local control

The “Headend Management” software (v2.14.40 or higher) is required, as well as a special lead (provided with the software) that connects a PC serial port to the “PRGM” socket of the MUX DVBS2-QAM/COFDM CI T.OX unit.

The software can be used to set up and read all the operating parameters, as well as to monitor the correct operation of the device.

b. Remote control

It is necessary to have a Headend Control module (Ref. 5559 or 555901) that includes the above mentioned software.

Once the communication with the headend control has been established, all the controllable devices that have been installed in the headend can be accessed. In this case it is imperative that each module is programmed with a different device address selected between 1 and 254.

Flow diagram of menus

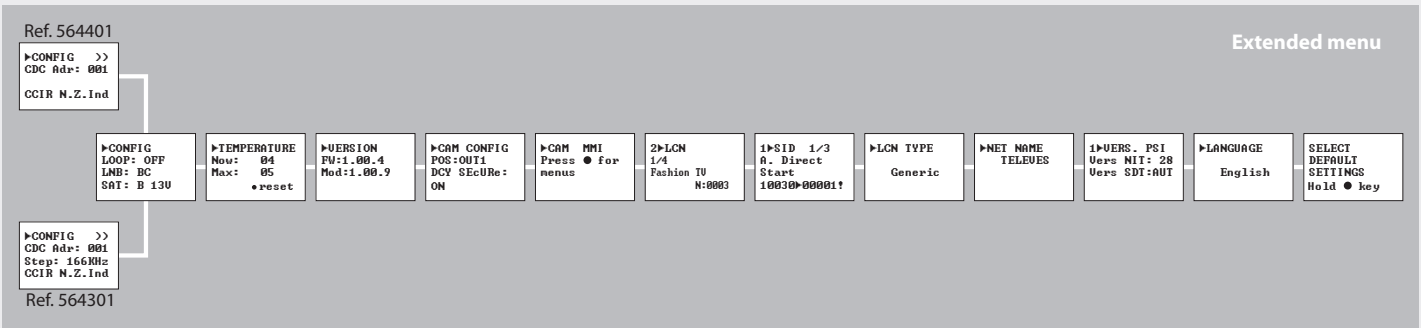
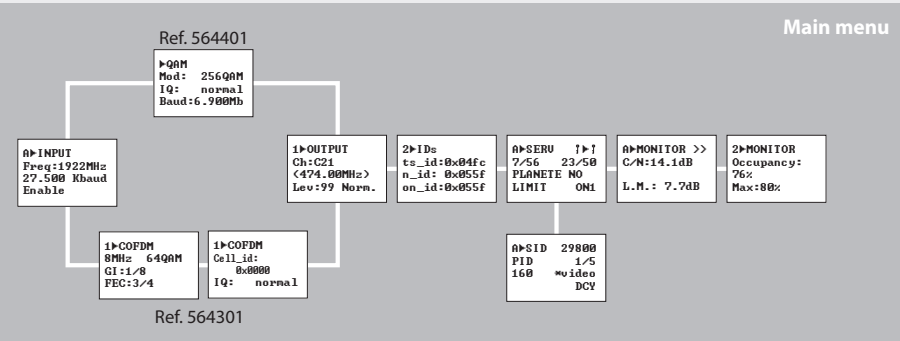

7. Example installation

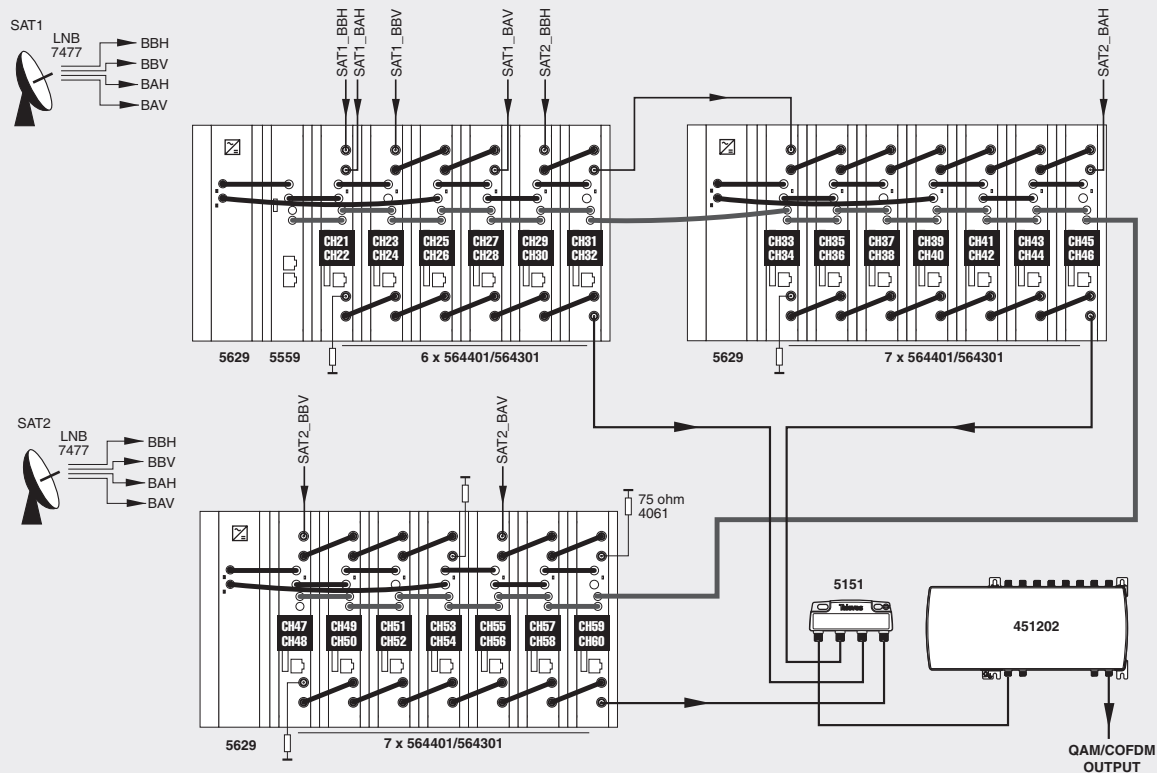

The illustration shows an installation to distribute 20 channels of MUX DVBS2_QAM/COFDM CI T-0X.

8. Norms for rack mounting (Max. 49 MUX CI T-0X - 7 subracks with 5 units in height - 8,7")

8.1. Installation of the rack with ventilation facilities

To facilitate the renewal and circulation of the air inside the rack, to reduce the temperature of the units and thus improving their characteristics, it is advisable to place 2 ventilation units of 25W, particularly when the rack with the MUX DVBS2_QAM/COFDM CI Twin T-0X is located in warm places, with temperatures higher than 45°C.

These ventilators will be installed on a tray that is fixed inside the cabinet (fig. 1 & 2). This way, the ventilators will force the fresh air entering from the base of the cabinet, to circulate between the modules and be expelled through a gap on top of the cabinet (3-5 cm approx.). See fig. 3.

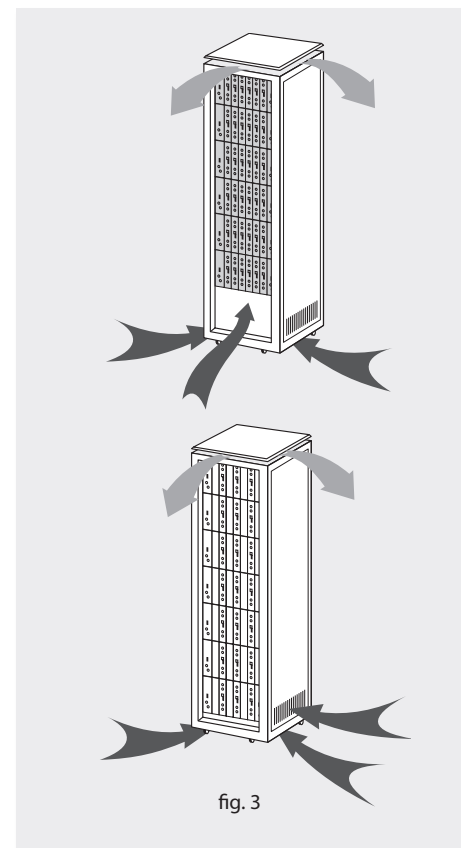
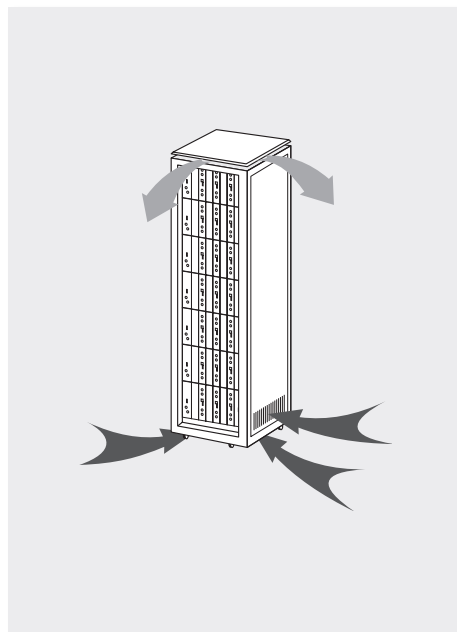
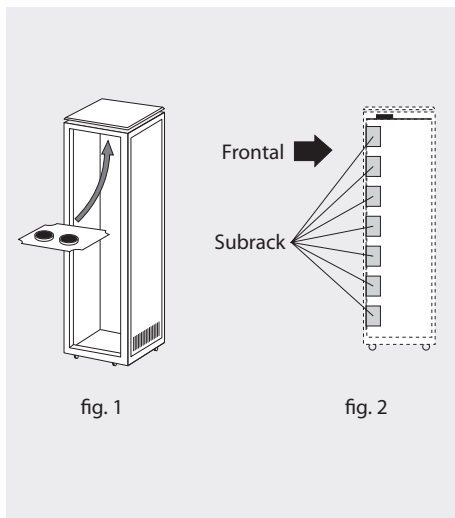

It is very important that this process operates correctly, therefore the following must be observed:

- Do not open the side doors, as this would cause the ventilators to extract the air from the outside rather than the air inside the rack.
- Do not place objects close to the rack that may block the entry and exit openings for the air.
- If the rack is not complete, the subracks must be placed from the top downwards without leaving any gaps in between, fig. 4.

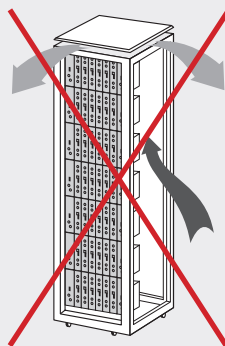
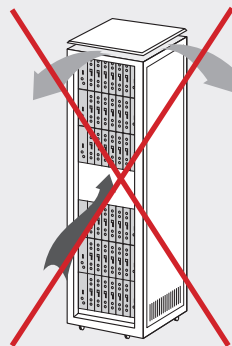
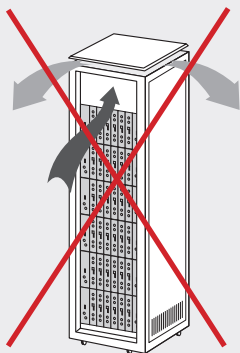

fig. 4

8.2. Installation of the rack without ventilation facilities

To install the units in racks without installation facilities, and when the rack is located in a place with a temperature of around 45°C, it is advisable to place the rack completely open, in other words, do not use the side doors. This is to facilitate the ventilation of the units, fig. 5.

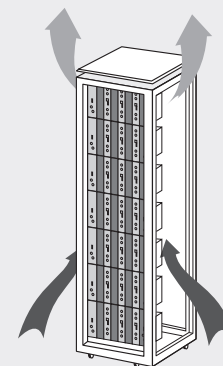

fig. 5

9. Norms for cabinet mounting

IMPORTANT

The scheme of recommended ventilation is the one in the figure in any case of cabinet placement (horizontal or vertical).

The maximum temperature permitted surrounding the highest cabinet is 45°C in both ways of placement, horizontal or vertical way.

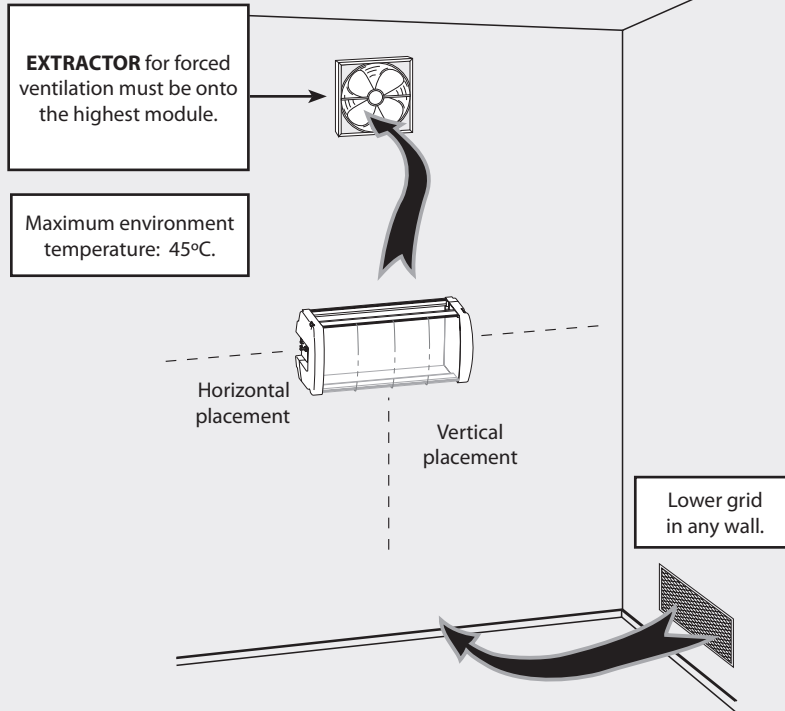



IMPORTANT

Horizontal placement of the cabinets is strongly recommended, hanging them as near to the floor as possible.

If the horizontal placement is impossible, then vertical placement is allowed.

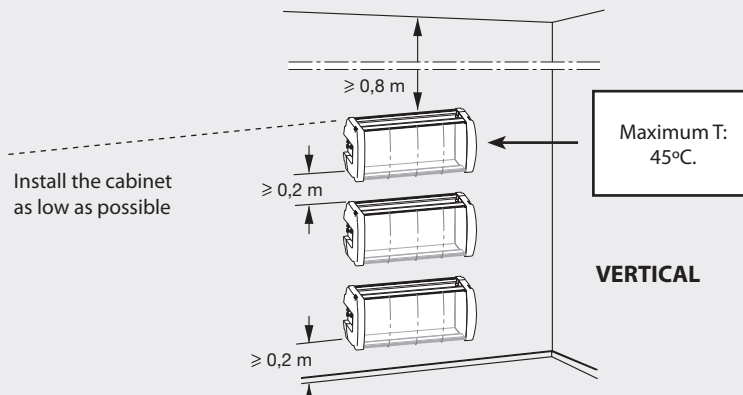
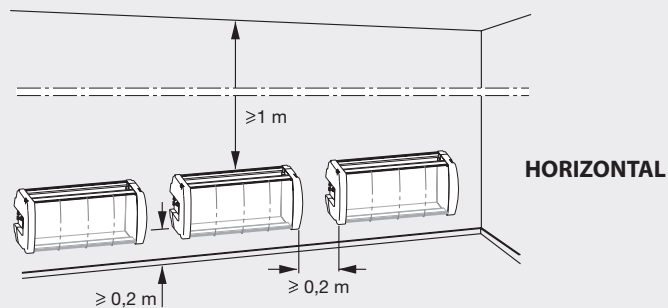
Respect the recommended minimum distances in the attached schemes.





DECLARATION OF CONFORMITY N° 140102132007

DECLARACIÓN DE CONFORMIDAD
DECLARACÃO DE CONFORMIDADE
DECLARATION DE CONFORMITE
DICHIARAZIONE DI CONFORMITÀ
DEKLARACJA ZGODNOSCI
DECLARATION DE CONFORMITATE
KONFORMITÄTSEKRLÄRUNG
CONFORMITÄTSEKRLÄRUNG
VASTAVISE SERTIFIKAAT
ATILISTIRAS DEKLARACIJA

KONFORMITÄTSEKRLÄRUNG
ΠΙΣΤΟΠΟΙΗΤΙΚΟ ΣΥΜΜΟΡΦΩΣΗΣ
FÖRSÄKRAN OM ÖVERENSSTÄMMELSE
VAATIMUSTENMUKAISUUSVAKUUTUS
ΑΤΤΙΚΗΤΗΣ ΔΕΚΛΑΡΑΣΙΑΣ
DEKLARACIJA SOVETSTVIETIA
MEGFELÉLŐSÉGI NYILATKOZAT
BEKREFTELSE
ДЕКЛАРАЦІЯ ВІДПОВІДНОСТІ
PROHLÁSENÍ O SHODĚ

Manufacturer / Fabricante / Fabricante / Fabricant / Fabrikant / Κατασκευαστής / Tilbederere / Valmistaja / Producten / Gaminiojas / Изготовитель / Produttore / Gyártó / Fabrikant / Produzent / Fabrikant / Биродавец / Valmistaja / Работник / Výrobce

Televes S.A.
Rua Benéfica de Conxco, 17 - 15706 - Santiago de Compostela - Spain

Declare under our own responsibility the conformity of the product / Declara bajo su exclusiva responsabilidad la conformidad del producto / Declara sob sua exclusiva responsabilidade a conformidade do produto / Declare sous notre propre responsabilité la conformité de ce produit / Dichiaro sotto la sua esclusiva responsabilità la conformità del prodotto / Wir übernehmen die Verantwortung für die Konformität des Produktes / Πρωτοσπουχη με δική μας ευθύνη την συμμόρφωση του προϊόντος / Försäkrar om överensstämelse enligt tillverkarens eget ansvar för produkten / Vastavastame yksitoimisen omalla vastuullamme tuotteen yhdenmukaista / Odpowiadamy na własną odpowiedzialność zgodność wyrobu / Deklaruємо саме atsakomybe, kad produktas yra atitinkamas / Завясаем с пазоўнай сваёй адмесцеаснасцю о саответнасцю прадукцыі / Declaram pe propria raspundeare ca produsul este in conformitate cu cerintele esentiale si certificate prevădite aplicabile / Saját felelősségünre kijelentjük, hogy a termék megfelel / Erklærer under vores eget ansvar overensstemmelse for produktet / Erklærer under vårt eget ansvar överensstämelsen för produkten / Wij nemen de verantwoordelijkheid voor de conformiteit van het product / Завясаем с пазоўнай сваёй аднасвіднасцю до аднасвіднасці прадукцыі / Kintaimame isote vastavast / Deklarē ar pilnu savu atbildību par produkta atbilstību / Prohlážíme na vlastní odpovědnost shodu výrobku:

Reference / Referencia / Referência / Référence / Articolo / Artikelnummer / Δήλωση / Referens / Referensi / Numer Katalogowy / Produkto numeris / Армушка / Referinta / Termékadám / Varenummer / Varenummer / Artikelnummer / Армушка / Viide / Atsauce / Reference:
564301

Description / Descripción / Descrição / Description / Beschreibung / Περιγραφή / Beskrivning / Kavvas / Opis / Produkto aprašas / Oncause / Descrerie / Leitnis / Beskrivelse / Beskrivelse / Beskrivning / Onuc / Kirjeldus / Apraksts / Popis:
T.0X DVBS2-COFDM CI TWIN MUX

Trademark / Marca / Marca / Marque / Marchio / Handelsmarke / Márka / Varumärke / Tavaramerkki / Marka / Prekės ženklas / Торговая марка / Marca / Märknavn / Varemärke / Varemärke / Handelsmerk / Търговска марка / Kaubamärk / Preča žme / Знаčka:
Televes

With the requirements of / Con los requerimientos de / Com as especificações de / Avec les conditions de / Con i requisiti di / Die Voraussetzungen erfüllen / Με τις απαιτήσεις του / Edligt följande bestämmelser / Svearvansen mättriktiken / Zgodność z wymogami / Atitinka reikalavimus / Требованията / In conformitate cu / Az alábbi követelményeek / Med bestemmelserne / In overeenstemming met / siduotību do umus / tingimustel / prasitām / S požadavky na:

- Low Voltage Directive 2006 / 95 / EC
- EMC Directive 2004 / 108 / EC

Following standards / Con las normas / Com as normas / Selon les normes / Con le norme / Folgende Anforderung / Ακόλουθα πρότυπα / Följande standard / Svearvansen standarden / Zastosowanie następujących norm / Pagal standartas / Сводных стандартов / Respectu urmatoarele standarde / A Kivotekés szabványokak / Följende standarder / Följende richtlijnen en normen / Наступних стандартів / Järgmistele standarditele / sekojostim standartiem / Následující normy:

EN 60728-11:2010, EN 50083-2:2012

Santiago de Compostela, 02/1/2014



José L. Fernández Carnero
Technical Director





DECLARATION OF CONFORMITY N° 140102131519

DECLARACIÓN DE CONFORMIDAD
DECLARACÃO DE CONFORMIDADE
DECLARATION DE CONFORMITE
DICHIARAZIONE DI CONFORMITÀ
DEKLARACJA ZGODNOSCI
DECLARATION DE CONFORMITATE
KONFORMITÄTSEKRLÄRUNG
CONFORMITÄTSEKRLÄRUNG
VASTAVISE SERTIFIKAAT
ATILISTIRAS DEKLARACIJA

KONFORMITÄTSEKRLÄRUNG
ΠΙΣΤΟΠΟΙΗΤΙΚΟ ΣΥΜΜΟΡΦΩΣΗΣ
FÖRSÄKRAN OM ÖVERENSSTÄMMELSE
VAATIMUSTENMUKAISUUSVAKUUTUS
ΑΤΤΙΚΗΤΗΣ ΔΕΚΛΑΡΑΣΙΑΣ
DEKLARACIJA SOVETSTVIETIA
MEGFELÉLŐSÉGI NYILATKOZAT
BEKREFTELSE
ДЕКЛАРАЦІЯ ВІДПОВІДНОСТІ
PROHLÁSENÍ O SHODĚ

Manufacturer / Fabricante / Fabricante / Fabricant / Fabrikant / Κατασκευαστής / Tilbederere / Valmistaja / Producten / Gaminiojas / Изготовитель / Produttore / Gyártó / Fabrikant / Produzent / Fabrikant / Биродавец / Valmistaja / Работник / Výrobce

Televes S.A.
Rua Benéfica de Conxco, 17 - 15706 - Santiago de Compostela - Spain

Declare under our own responsibility the conformity of the product / Declara bajo su exclusiva responsabilidad la conformidad del producto / Declara sob sua exclusiva responsabilidade a conformidade do produto / Declare sous notre propre responsabilité la conformité de ce produit / Dichiaro sotto la sua esclusiva responsabilità la conformità del prodotto / Wir übernehmen die Verantwortung für die Konformität des Produktes / Πρωτοσπουχη με δική μας ευθύνη την συμμόρφωση του προϊόντος / Försäkrar om överensstämelse enligt tillverkarens eget ansvar för produkten / Vastavastame yksitoimisen omalla vastuullamme tuotteen yhdenmukaista / Odpowiadamy na własną odpowiedzialność zgodność wyrobu / Deklaruємо саме atsakomybe, kad produktas yra atitinkamas / Завясаем с пазоўнай сваёй адмесцеаснасцю о саответнасцю прадукцыі / Declaram pe propria raspundeare ca produsul este in conformitate cu cerintele esentiale si certificate prevădite aplicabile / Saját felelősségünre kijelentjük, hogy a termék megfelel / Erklærer under vores eget ansvar overensstemmelse for produktet / Erklærer under vårt eget ansvar överensstämelsen för produkten / Wij nemen de verantwoordelijkheid voor de conformiteit van het product / Завясаем с пазоўнай сваёй аднасвіднасцю до аднасвіднасці прадукцыі / Kintaimame isote vastavast / Deklarē ar pilnu savu atbildību par produkta atbilstību / Prohlážíme na vlastní odpovědnost shodu výrobku:

Reference / Referencia / Referência / Référence / Articolo / Artikelnummer / Δήλωση / Referens / Referensi / Numer Katalogowy / Produkto numeris / Армушка / Referinta / Termékadám / Varenummer / Varenummer / Artikelnummer / Армушка / Viide / Atsauce / Reference:
564401

Description / Descripción / Descrição / Description / Beschreibung / Περιγραφή / Beskrivning / Kavvas / Opis / Produkto aprašas / Oncause / Descrerie / Leitnis / Beskrivelse / Beskrivelse / Beskrivning / Onuc / Kirjeldus / Apraksts / Popis:
T.0X DVBS2-QAM CI TWIN MUX

Trademark / Marca / Marca / Marque / Marchio / Handelsmarke / Márka / Varumärke / Tavaramerkki / Marka / Prekės ženklas / Торговая марка / Marca / Märknavn / Varemärke / Varemärke / Handelsmerk / Търговска марка / Kaubamärk / Preča žme / Знаčka:
Televes

With the requirements of / Con los requerimientos de / Com as especificações de / Avec les conditions de / Con i requisiti di / Die Voraussetzungen erfüllen / Με τις απαιτήσεις του / Edligt följande bestämmelser / Svearvansen mättriktiken / Zgodność z wymogami / Atitinka reikalavimus / Требованията / In conformitate cu / Az alábbi követelményeek / Med bestemmelserne / In overeenstemming met / siduotību do umus / tingimustel / prasitām / S požadavky na:

- Low Voltage Directive 2006 / 95 / EC
- EMC Directive 2004 / 108 / EC

Following standards / Con las normas / Com as normas / Selon les normes / Con le norme / Folgende Anforderung / Ακόλουθα πρότυπα / Följande standard / Svearvansen standarden / Zastosowanie następujących norm / Pagal standartas / Сводных стандартов / Respectu urmatoarele standarde / A Kivotekés szabványokak / Följende standarder / Följende richtlijnen en normen / Наступних стандартів / Järgmistele standarditele / sekojostim standartiem / Následující normy:

EN 60728-11:2010, EN 50083-2:2012

Santiago de Compostela, 02/1/2014

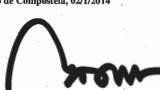

José L. Fernández Carnero
Technical Director



Guarantee

Televes S.A. offers a two year guarantee, beginning from the date of purchase for countries in the EU. For countries that are not part of the EU, the legal guarantee that is in force at the time of purchase is applied. Keep the purchase invoice to determine this date.

During the guarantee period, Televes S.A. complies with the guarantee by repairing or substituting the faulty equipment.

The harm produced by improper usage, wear and tear, manipulation by a third party, catastrophes or any other cause beyond the control of Televes S.A. is not included in the guarantee.

Televés

European technology **Made in**  **EU**rope